

**FABER**  
FRANKE'S AIR EXPERT



**FRANKE**



**ELGRAD**

KOLEKCIJA  
2025

# Sadržaj



Integrirane nape u indukcijsku ploču	08
Indukcijske ploče za kuhanje	10
Zidne nape - Zero Drip Technology	12
Zidne nape - dizajnerske	12
Zidne nape - vertikalne	13
Zidne nape - T-oblik	14
Zidne nape - kaminske	15
Otočne nape	16
Ugradbene i teleskopske nape	17
Klasične nape	21
Dekorativne Country nape	22
Pribor za nape	23



Korita od nehrđajućeg čelika	38
Sudoperi od nehrđajućeg čelika	46
Korita od fragranita	51
Sudoperi od fragranita	56
Dodatni pribor sudoperi - drobilice otpada	62
Slavine - krom	64
Slavine - crna mat	67
Slavine - krom-fragranit	69
Slavine - fragranit	70
Slavine - rustikalne	71



 **FABER**  
FRANKE'S AIR EXPERT

**70**  
YEARS

Kolekcija 2025

# OBRATITE PAŽNJU

## PRAVILNO MJERENJE USISNOG KAPACITETA NAPE

**Podaci o izvedbi iskazani u ovom katalogu mjereni su prema novom kodeksu**, koji su potpisali najkvalificiraniji europski proizvođači udruženi u CECED (Europsko udruženje proizvođača domaće i profesionalne opreme). To je strogi kodeks određen radi transparentnosti podataka kapaciteta i buke napa, mjernih pravila zajedničkih svim proizvođačima:

- **sposobnost usisavanja prema IEC / EN 61591 standardu (napa s odvodom zraka)**
- razina buke u skladu s IEC / EN 60704-3 standardom

### PROTOK ZRAKA MOTORA

Jedan od pogrešnih načina mjerenja kapaciteta nape je mjerenje protoka zraka u motoru, bez ikakvog otpora (motor pritom nije ugrađen u napu, a time nema otpora niti filtera, niti otpora prilikom kanaliziranja zraka u izlaznu cijev).

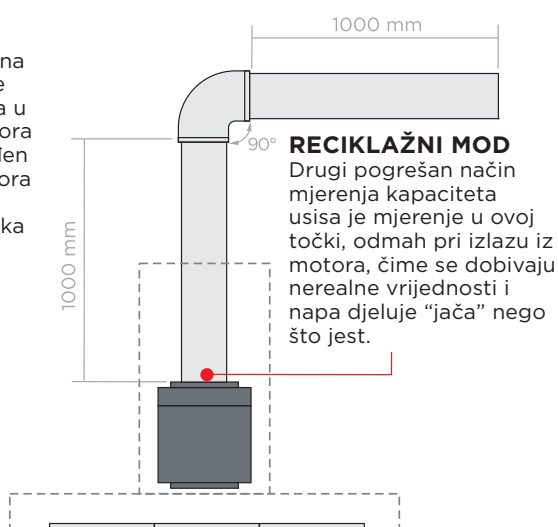
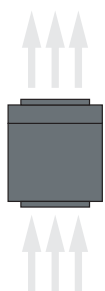

#### RECIKLAŽNI MOD

Drugi pogrešan način mjerenja kapaciteta usisa je mjerenje u ovoj točki, odmah pri izlazu iz motora, čime se dobivaju nerealne vrijednosti i napa djeluje "jača" nego što jest.

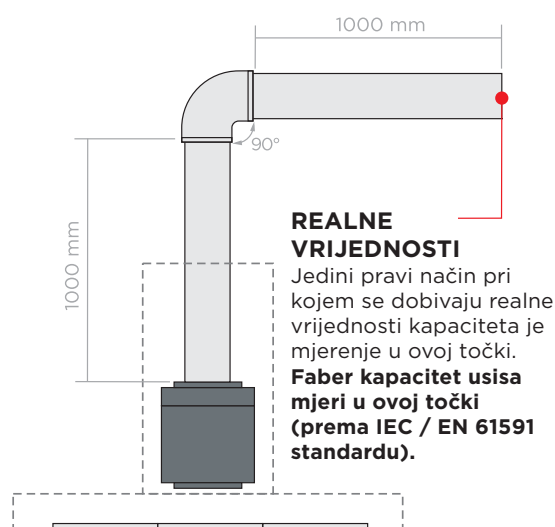

#### REALNE VRIJEDNOSTI

Jedini pravi način pri kojem se dobivaju realne vrijednosti kapaciteta je mjerenje u ovoj točki. **Faber kapacitet usisa mjeri u ovoj točki (prema IEC / EN 61591 standardu).**

### PRAVILNO MJERENJE USISNOG KAPACITETA - REALNE VRIJEDNOSTI

Usisni kapacitet mjeri se kod standardne odvodne cijevi duljine 1 dužnog metra + zavoј pod kutem 90°+ 1 dužni metar, promjera 120 mm.

Metoda mjerenja prema IEC / EN 61591 standardu vjerno reproducira tipične uvjete ugradnje i uporabe i osigurava stvarne, pouzdane informacije.

Obratite pozornost na to da li napa zadovoljava ove norme - na ovaj način možete pružene informacije smatrati ispravnima i pouzdanima, kao kod Faberovih napa.

Sve informacije o tehničkim podacima i značajkama, uključujući količine masnoća koje zaustavljaju filteri i jačine osvjetljenja, mjere se u Faberovim laboratorijima, koji su ovlaštene za takva ispitivanja od strane IMQ i NEMKO.

### CERTIFIKATI

#### IMQ

Talijanski znak kvalitete, priznat u Europskoj uniji.

#### SEMKO

Semko je dio Intertek ETL-a, svjetskog lidera u certifikaciji proizvoda.

#### UL

Američki i kanadski znak za kvalitetu.

#### CCC

Kineski znak za kvalitetu.

# PRIJE KUPNJE

## ABECEDA KUHINJSKE NAPE

**Napa s odvodom zraka izbacuje mirise i izvlači paru nastalu u kuhinji. Ona predstavlja najefikasnije rješenje.**

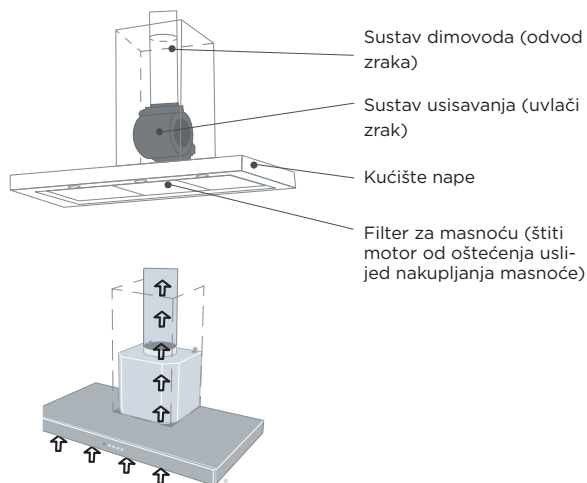

**Filtracijska napa izvlači zrak, filtrira mirise i paru, a zatim u kuhinju vraća pročišćeni zrak.**

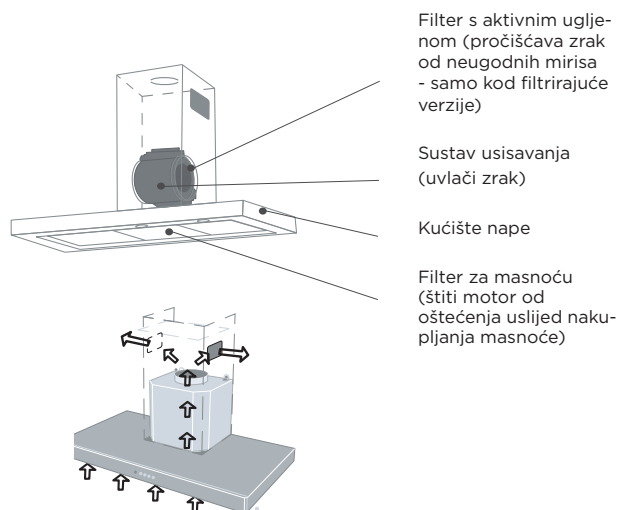

## ODABERITE ODGOVARAJUĆU NAPU

Potreban kapacitet usisavanja određuje se prema veličini vaše kuhinje. Učinkovita napa radi 10 izmjena zraka po satu<sup>1</sup>.

Jači motor je tiši i koristi manje energije jer je učinkovitiji na malim brzinama

- Ukoliko je usisni kapacitet nape dovoljan, napa ne proizvodi buku i ne prelazi jačinu zvuka iznad 55 dB(A)

-Prilagođene brzine omogućuju odabir odgovarajuće razine usisavanja zraka uz minimalnu buku.

<sup>1</sup> Fan Handbook - F. Bleier 1998

$$\text{UČINKOVITOST} = \frac{\text{površina kuhinje u m}^2 \times \text{visina kuhinje}}{10} \times \text{izmjena zraka}$$

### Primjer:

Kuhinja veličine 15 m<sup>2</sup>, visine 3 m, zahtijeva napu usisnog kapaciteta od minimalno 450 m<sup>3</sup>/h.

Odnosno: 15 m<sup>2</sup> x 3 m x 10 = 450 m<sup>3</sup>/h.

Pogledajte tablicu priloženu u katalogu proizvoda. Kapacitet nape je odgovarajući ukoliko se u jednoj od kolona brzine nalazi jednaka ili viša vrijednost kapaciteta.

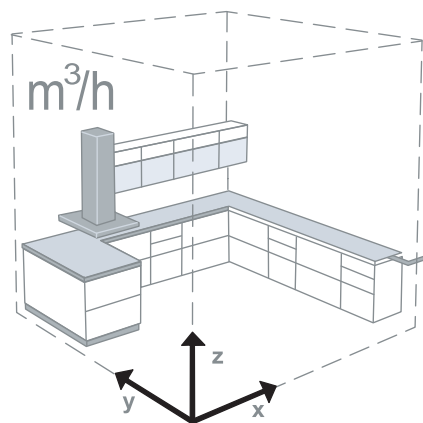

### PERFORMANSE

Brzina	1	2	3	MAX	INT
Kapacitet usisa (IEC)	220	365	420	645	880
Pritisak	410	430	435	510	610
Snaga	10	25	35	105	270
Razina buke	41	53	56	67	73

## FABER CLOUD



Ekskluzivna aplikacija Faber Cloud može se koristiti za praćenje kvalitete zraka u vašoj kuhinji i podešavanje glavnih postavki nape u bilo kojem trenutku, čak i s mobitela.

## K-LINK



Uz radio vezu između nape i Faberove indukcijske ploče za kuhanje, snaga usisavanja automatski se podešava prema odabranoj razini kuhanja kako bi se optimizirale performanse i izbjegao nepotreban trošak.

## SOUND PRO



Smanjenjem turbulencije i vrtloga u unutarnjem strujanju zraka, nova tehnologija nape uspijeva ograničiti buku i poboljšati kvalitetu zvuka nape.

## SIL & STILL



Zahvaljujući SIL & STILL tehnologiji, nape iz Still linije proizvode samo 52 dB(A) buke pri punoj snazi. Povrh toga, ako se odabere Eco funkcija, koja kombinira SIL & STILL sa motorom bez četkica (BRUSHLESS), napa prelazi u ultratih mod sa manje od 40 dB(A) buke.

## ZERO DRIP



Zaustavite kondenzaciju! Zero Drip skuplja kondenzat u okvir sprečavajući da kaplje na ploču za kuhanje. Zero Drip Plus uzrokuje isparavanje kondenzata zahvaljujući posebno zagrijanom staklu nape.

## BRUSHLESS



Motor bez četkica osigurava značajnu uštedu energije u kombinaciji s visokom učinkovitosti ekstrakcije. To je najtiši motor na tržištu, a njegova svojstva ostaju jednaka u svim uvjetima korištenja.

## WATERPROOF



Svaka tekućina prolivena tijekom kuhanja ulijeva se izravno u usisnu rešetku i sakuplja se automatski u odvodnu pliticu ispod nape, dovoljno malu da ostane mjesta za ladicu za posuđe.

## POWER MANAGEMENT



Postavka apsorpcije podesiva je na 4 razine snage (kW). Nema više prekida napajanja uslijed preopterećenja!

## REAR OUTLET



Omogućuje odvod pare i mirisa u otvor iza same nape umjesto iznad. To eliminira potrebu za gornjim odvodom i oslobađa prostor iznad nape.

## IZDVOJEN MOTOR



Mogućnost ugradnje motora dalje od nape, daje veću slobodu pri dizajniranju napa te smanjuje buku u kuhinji.

## HFH FILTERING



HFH: visoko učinkovit, ekskluzivni Faberov sustav filtriranja aktivnim ugljenom, koji u usporedbi s tradicionalnim ugljenim filterom poboljšava eliminacije neugodnih mirisa (95%).

## FILTER ALARM



Upozorenje zasićenja filtera: upozorava korisnika kada je potrebno očistiti filter masnoće ili zamijeniti filter mirisa.

## SELF START



Posebni senzor uključuje napu čim temperatura zraka dosegne 35°C. Pametni senzor koji omogućuje samoaktivirajuće pokretanje kuhinjske nape, samo kada je to potrebno. Tako je omogućeno optimalno iskorištenje usisa nape i olakšan rad u kuhinji.

## OBODNI USIS



Smanjuje doživljenu buku za 25% (\*). Visokorazvijeni sustav obodnog usisavanja po principu Venturijevog efekta: zrak ubrzava kako se približava i prolazi kroz suženi prostor usisa, nakon čega unutar nape odmah usporava i lako se izbacuje bez potrebe za posebno jakim pritiskom. (\*) Odgovara smanjenju buke od 3 dB (A) sukladno normi EN 60704-3

## AUTOMATSKA FUNKCIJA



Napa se automatski uključuje najprikladnijom brzinom, prilagođavajući kapacitet usisa maksimalnoj razini kuhanja.

## HOUR 24



Tipka 24: pokretanjem ove funkcije napa radi 24 sata dnevno, radi konstantne izmjene zraka u prostoru, uz potpuno bešuman rad.

### DELAY 30



Odgođeno gašenje nape: omogućuje odgodu prestanka rada nape kako bi izvukla zaostale mirise i pare nakon prestanka kuhanja.

### SPEED I



Intenzivan rad (brzina): funkcija koja aktivira maksimalan kapacitet izvlačenja zraka na 6 minuta, nakon čega se vraća na zadnju podešenu brzinu.

### BOOST



Ova dodatna snaga motora nape ima mogućnost da usiše i najmanji ostatak pare i mirisa u par minuta.

### LED LIGHT



Zahvaljujući LED rasvjeti imat ćete odlično osvijetljenje i izvrsnu vidljivost na cijelom području kuhanja, uz znatnu uštedu energije.

### LED LIGHT DIMMER

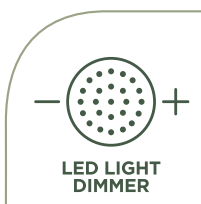

Svjetlo koje se može prigušiti: pritiskom na tipku svjetlo se priguši i može ostati dugo uključeno uz minimalnu potrošnju energije.

### TUNABLE WHITE



Na nekim modelima možete odabrati i mijenjati temperaturu boje svjetlosti, od toplije (prema žutoj) do hladnije (prema bijeloj).

### ANTI TOUCH



Inox bez otisaka prstiju za savršeno čistu napu i površinu bez dosadnih nečistoća.

### TOUCH CONTROL

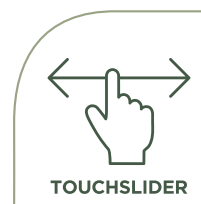

Iznimno ugodne Touch Slider kontrole jednostavne za uporabu.

### SUCTION SPEED



Maksimalna sigurnost u kuhinji. Pametnim fluidno-dinamičkim dizajnom Galileo se ističe visokim kapacitetom usisa do 6,6 metara u sekundi. Ima moć eliminirati veliku količinu pare i mirisa u samo nekoliko minuta.

### REMOTE CONTROL



Novi daljinski upravljač kompatibilan je s mnogim Faberovim napama. Za podešavanje usisavanja i posebnih funkcija, kao što su prigušeno svjetlo, značajke 24H, Up&Down i Steam Off. Upravljanje napom je lakše no ikad.

# INTEGRIRANE NAPE U INDUKCIJSKU PLOČU

## GALILEO NG



**FUN:** 340.0594.624

Crno staklo/  
lijevano željezo

**4.999,00 KM**



**M<sup>3</sup>/H** BOOST 700 **RAZINA BUKE dB(A)** BOOST 72



**W** 7400 **830x520 mm**



## GALILEO STRIPES



**FUN:** 340.0708.969

Crno staklo/Dizajnerska rešetka sa ukrasom od nehrđ. čelika Filtracijska

**4.399,00 KM**

**FUN:** 340.0708.968

Crno staklo/Dizajnerska rešetka sa ukrasom od nehrđ. čelika Ekstrakcijska

**4.199,00 KM**



**M<sup>3</sup>/H** BOOST 600 **RAZINA BUKE dB(A)** BOOST 72



**W** 7400 **830x520 mm**

## GALILEO SMART



**FUN:** 340.0577.694

Crno staklo/  
lijevano željezo

**3.799,00 KM**



**M<sup>3</sup>/H** BOOST 700 **RAZINA BUKE dB(A)** BOOST 72



**W** 7400 **830x520 mm**



Galileo se ističe zbog svoje vodootporne tehnologije motora, koja jamči normalno funkcioniranje i potpunu sigurnost čak i kad se na ploči za kuhanje proljeva velika količina tekućine.



Kompaktni dizajn motora znači da je Galileo jedini proizvod u svojoj klasi koji ostavlja dovoljno slobodnog prostora unutar ormarića kako bi se ladicica postavila odmah ispod ploče.

# INTEGRIRANE NAPE U INDUKCIJSKU PLOČU



## GALILEO BOLD



**FUN:** 340.0708.971  
Crno staklo/Dizajnerska rešetka od nehrđajućeg čelika  
Filtracijska

**3.699,00 KM**

**FUN:** 340.0708.973  
Crno staklo/Dizajnerska rešetka od nehrđajućeg čelika  
Ekstrakcijska

**3.499,00 KM**

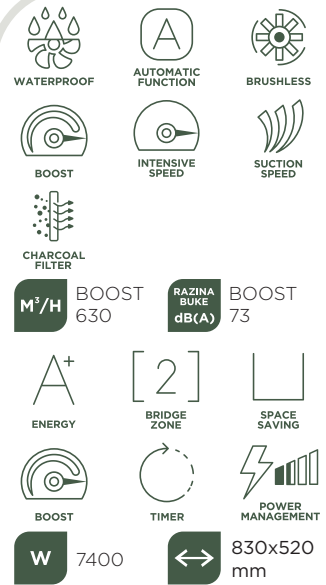

## GALILEO LINEAR



**FUN:** 340.0708.970  
Crno staklo/Dizajnerska crna rešetka  
Filtracijska

**3.299,00 KM**

**FUN:** 340.0708.972  
Crno staklo/Dizajnerska crna rešetka  
Ekstrakcijska

**3.099,00 KM**



## GALILEO 60



**FUN:** 340.0627.227  
Crno staklo/  
čelična rešetka

**3.199,00 KM**



## GALILEO SLIM



**FUN:** 340.0708.974  
Crno staklo/Dizajnerska crna rešetka  
Filtracijska

**3.199,00 KM**

**FUN:** 340.0708.975  
Crno staklo/Dizajnerska crna rešetka  
Ekstrakcijska

**2.999,00 KM**



## DEKORATIVNA REŠETKA GALILEO SLIM

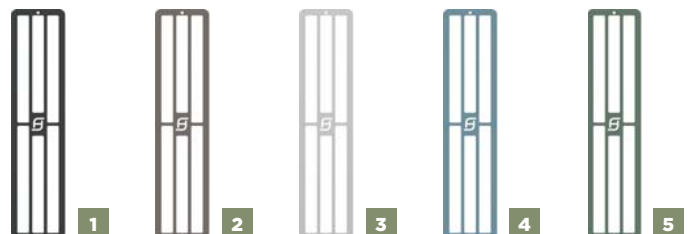

Galileo Slim uvijek se isporučuje s crnom rešetkom kao standard.  
Postoji mogućnost prilagodbe odabirom jedne od pet elegantnih rešetki u boji.

- 1 FUN:** 112.0717.358 Dekorativna rešetka Galileo Slim tamno siva mat
- 2 FUN:** 112.0717.359 Dekorativna rešetka Galileo Slim titan mat
- 3 FUN:** 112.0717.374 Dekorativna rešetka Galileo Slim aluminij mat
- 4 FUN:** 112.0717.360 Dekorativna rešetka Galileo Slim prašnjavo plava mat
- 5 FUN:** 112.0717.361 Dekorativna rešetka Galileo Slim prašnjavo zelena mat

## INDUKCIJSKE PLOČE ZA KUHANJE

### INDUKCIJSKA PLOČA FCH95



FUN: 108.0604.943  
Crno staklo  
**1.699,00 KM**

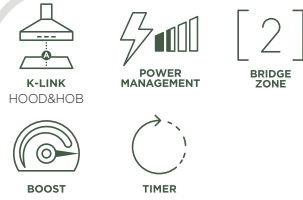

W 7400 900x520 mm



### INDUKCIJSKA PLOČA FCH SLIM 94



FUN: 108.0604.942  
Crno staklo  
**1.699,00 KM**

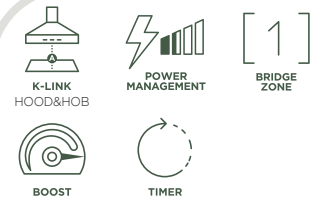

W 7400 900x410 mm

### INDUKCIJSKA PLOČA FCH84



FUN: 108.0604.935  
Crno staklo  
**1.399,00 KM**

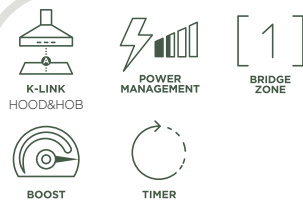

W 7400 780x520 mm



# INDUKCIJSKE PLOČE ZA KUHANJE



## INDUKCIJSKA PLOČA FCH64

FUN: 108.0604.933  
Crno staklo  
**1.199,00 KM**

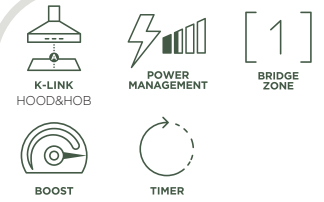

**W** 7400 **↔** 580x520 mm

## INDUKCIJSKA PLOČA FBH64

FUN: 108.0604.932  
Crno staklo  
**999,00 KM**



**W** 7400 **↔** 580x520 mm



## INDUKCIJSKA PLOČA FBH32

FUN: 108.0604.931  
Crno staklo  
**699,00 KM**



**W** 3700 **↔** 290x520 mm



## ZIDNE NAPE - ZERO DRIP TECHNOLOGY



Zaustavite kondenzaciju!



### ZERO DRIP

Zero Drip skuplja kondenzat u okvir sprečavajući da kaplje na ploču za kuhanje.



### ZERO DRIP PLUS

Zero Drip Plus uzrokuje isparavanje kondenzata zahvaljujući posebno zagrijanom staklu nape.

## GLAM LIGHT ZERO DRIP PLUS

NOVO\*



FUN: 330.0615.735  
Mat crno staklo K-LINK 800 mm

2.049,00 KM

FUN: 330.0615.681  
Staklo boja pijeska 800 mm\*

1.999,00 KM

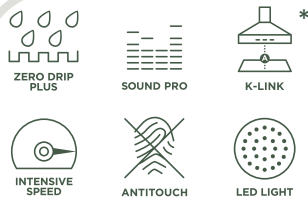

\*K-LINK samo neki modeli



A ENERGY

RAZINA BUKE dB(A) INT 68

M<sup>3</sup>/H INT 740

800 mm

## GLAM LIGHT ZERO DRIP



FUN: 330.0615.676  
Crno staklo 800 mm

1.429,00 KM

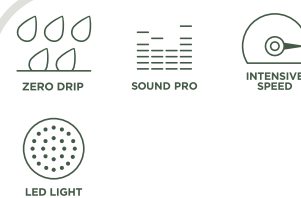

B ENERGY

RAZINA BUKE dB(A) INT 67

M<sup>3</sup>/H INT 750

800 mm

## ZIDNE NAPE - DIZAJNERSKE

## CYLINDRA GLOSS PLUS



FUN: 335.0492.565  
Bijela sjajna 370 mm

1.799,00 KM



A ENERGY

RAZINA BUKE dB(A) INT 68

M<sup>3</sup>/H INT 700

370 mm

## CYLINDRA PLUS



FUN: 335.0606.998  
Crna mat 370 mm

1.799,00 KM



A ENERGY

RAZINA BUKE dB(A) INT 69

M<sup>3</sup>/H INT 700

370 mm

## ZIDNE NAPE - DIZAJNERSKE

### CYLINDRA



**C** ENERGY  
**RAZINA BUKE** dB(A) INT 68  
**M<sup>3</sup>/H** INT 660  
**↔** 370 mm

**FUN:** 110.0332.307  
 Nehrdajući čelik 370 mm  
**1.339,00 KM**

### ECLIPSE

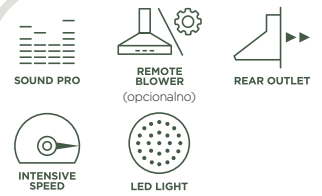

**C** ENERGY  
**RAZINA BUKE** dB(A) INT 70  
**M<sup>3</sup>/H** INT 620  
**↔** 370 mm

**FUN:** 335.0538.983  
 Nehrdajući čelik 370 mm  
**1.039,00 KM**

## ZIDNE NAPE - VERTIKALNE

### DAISY PLUS



**A<sup>+</sup>** ENERGY  
**RAZINA BUKE** dB(A) INT 68  
**M<sup>3</sup>/H** INT 770  
**↔** 550 mm / 800 mm

**FUN:** 330.0612.373 Crno staklo 550 mm **899,00 KM**  
**FUN:** 330.0612.375 Bijelo staklo 550 mm **949,00 KM**  
**FUN:** 330.0612.374 Crno staklo 800 mm **999,00 KM**  
**FUN:** 330.0612.371 Bijelo staklo 800 mm **1.049,00 KM**



### STEELMAX

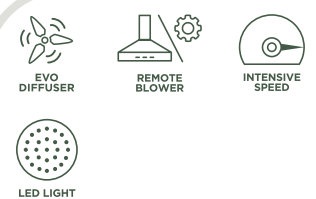

**B** ENERGY  
**RAZINA BUKE** dB(A) INT 67  
**M<sup>3</sup>/H** INT 750  
**↔** 550 mm / 800 mm

**FUN:** 330.0538.524 Crno staklo 550 mm **799,00 KM**  
**FUN:** 330.0538.525 Bijelo staklo 550 mm **799,00 KM**  
**FUN:** 330.0538.526 Crno staklo 800 mm **849,00 KM**  
**FUN:** 330.0538.523 Bijelo staklo 800 mm **849,00 KM**

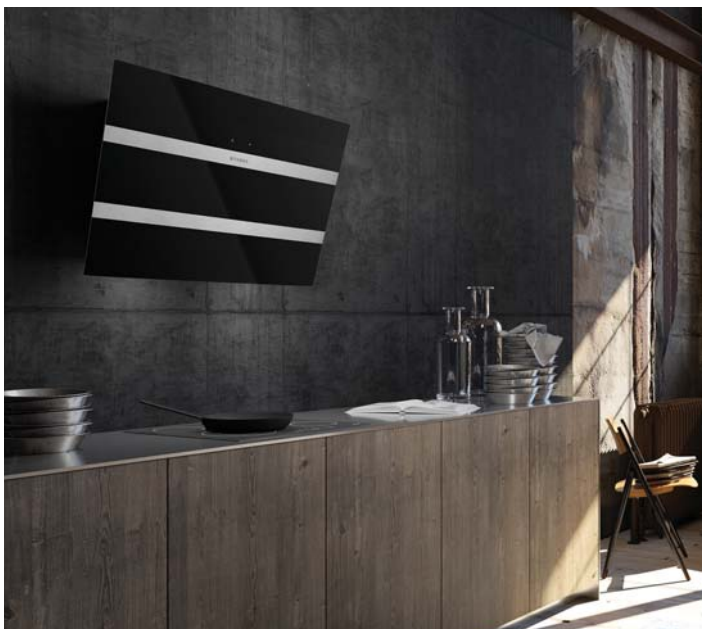

## ZIDNE NAPE - VERTIKALNE



### TWEET



**FUN:** 330.0529.664  
Crno staklo  
550 mm

**599,00 KM**

**FUN:** 330.0529.665  
Bijelo staklo  
550 mm

**629,00 KM**

**FUN:** 330.0529.666  
Crno staklo  
800 mm

**639,00 KM**

**FUN:** 330.0529.667  
Bijelo staklo  
800 mm

**669,00 KM**



RAZINA BUKE  
dB(A) INT  
67

M<sup>3</sup>/H INT  
710

←→ 550 mm  
800 mm

### VRT



DELAY 5



LED LIGHT

**FUN:** 330.0567.491  
Crno staklo 600 mm

**499,00 KM**

**FUN:** 330.0567.492  
Crno staklo 900 mm

**539,00 KM**



RAZINA BUKE  
dB(A) MAX  
67

M<sup>3</sup>/H MAX  
580

←→ 600 mm  
900 mm



## ZIDNE NAPE - T-OBLIK

### STILO COMFORT



SOUND PRO



HIGH FILTERING  
KIT (opcionalno)



REMOTE BLOWER  
(opcionalno)



INTENSIVE  
SPEED



LED LIGHT

**FUN:** 325.0615.637  
Nehrd. čelik 600 mm

**669,00 KM**

**FUN:** 325.0618.791  
Crna mat 600 mm

**779,00 KM**

**FUN:** 325.0615.636  
Nehrd. čelik 900 mm

**729,00 KM**

**FUN:** 325.0618.783  
Crna mat 900 mm

**839,00 KM**

**FUN:** 325.0615.638  
Nehrd. čelik 1200 mm

**959,00 KM**

**FUN:** 325.0618.787  
Crna mat 1200 mm

**1.069,00 KM**



RAZINA BUKE  
dB(A) INT  
69

M<sup>3</sup>/H INT  
710

←→ 600 mm  
900 mm  
1200 mm

### STILO SMART



SOUND PRO



HIGH FILTERING  
KIT (opcionalno)



REMOTE BLOWER  
(opcionalno)



LED LIGHT

**FUN:** 325.0615.633  
Nehrdajući čelik 600 mm

**529,00 KM**

**FUN:** 325.0615.635  
Nehrdajući čelik 900 mm

**589,00 KM**



RAZINA BUKE  
dB(A) MAX  
67

M<sup>3</sup>/H MAX  
430

←→ 600 mm  
900 mm

## ZIDNE NAPE - KAMINSKE

### TENDER



FUN: 110.0157.048  
Nehrdajući čelik 600 mm

**489,00 KM**

FUN: 110.0157.049  
Nehrdajući čelik 900 mm

**529,00 KM**



### STRIP SMART EV8



FUN: 320.0533.680  
Nehrdajući čelik 600 mm

**479,00 KM**

FUN: 320.0533.761  
Nehrdajući čelik 900 mm

**539,00 KM**



### STRIP SMART PB



FUN: 320.0685.190 Crna 600 mm

**319,00 KM**

FUN: 320.0685.189  
Nehrd. čelik 600 mm

**299,00 KM**

FUN: 320.0685.191  
Crna 900 mm

**349,00 KM**



### VALUE BK



FUN: 320.0557.543  
Crna 600 mm

**249,00 KM**

FUN: 320.0557.544  
Crna 900 mm

**289,00 KM**



VALUE BK

### VALUE



FUN: 320.0557.533  
Nehrdajući čelik 600 mm

**229,00 KM**

FUN: 320.0557.534  
Nehrdajući čelik 900 mm

**269,00 KM**



# OTOČNE NAPE

## CYLINDRA ISOLA PLUS



FUN: 335.0572.104  
Crna mat 370 mm  
**2.199,00 KM**

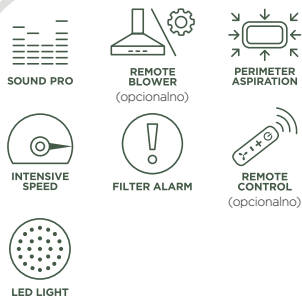

**A** ENERGY RAZINA BUKE dB(A) INT 69  
**M<sup>3</sup>/H** INT 700 **↔** 370 mm



## CYLINDRA ISOLA GLOSS PLUS



FUN: 335.0492.563  
Bijela sjajna 370 mm  
**2.199,00 KM**



**A** ENERGY RAZINA BUKE dB(A) INT 69  
**M<sup>3</sup>/H** INT 700 **↔** 370 mm

## CYLINDRA ISOLA



FUN: 110.0332.308  
Nehrdajući čelik 370 mm  
**1.769,00 KM**



**C** ENERGY RAZINA BUKE dB(A) INT 68  
**M<sup>3</sup>/H** INT 660 **↔** 370 mm



## STILO GLASS SMART ISOLA



FUN: 325.0618.802  
Nehrdajući čelik 900 mm  
**1.599,00 KM**

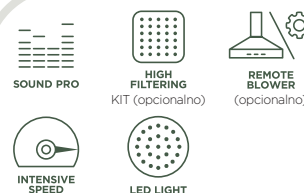

**B** ENERGY RAZINA BUKE dB(A) INT 69  
**M<sup>3</sup>/H** INT 710 **↔** 900 mm

## OTOČNE NAPE

### STILO COMFORT ISOLA



**FUN:** 325.0618.738  
Nehrdajući čelik  
900 mm

**1.569,00 KM**

**FUN:** 325.0618.792  
Crna mat  
900 mm

**1.699,00 KM**

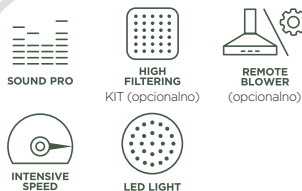

**B**  
ENERGY

**RAZINA  
BUKE  
dB(A)** INT  
69

**M<sup>3</sup>/H** INT  
710

**↔** 900 mm

### GLASSY ISOLA/SP



**FUN:** 325.0617.019  
Nehrdajući čelik/staklo 900 mm

**1.449,00 KM**

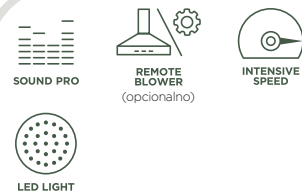

**B**  
ENERGY

**RAZINA  
BUKE  
dB(A)** INT  
70

**M<sup>3</sup>/H** INT  
700

**↔** 900 mm

## UGRADBENE I TELESKOPSKE NAPE

### IN-NOVA ZERO DRIP



**FUN:** 305.0626.490  
Nehrdajući čelik/bijelo staklo 600 mm

**1.699,00 KM**

**FUN:** 305.0626.489  
Nehrdajući čelik/bijelo staklo 900 mm

**1.799,00 KM**

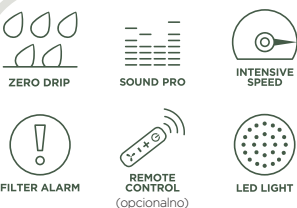

**A**  
ENERGY

**RAZINA  
BUKE  
dB(A)** INT  
69

**M<sup>3</sup>/H** INT  
710

**↔** 600 mm  
900 mm  
1200 mm



### IN-NOVA PREMIUM



**FUN:** 110.0439.940  
Nehrdajući čelik/  
staklo 600 mm

**1.229,00 KM**

**FUN:** 305.0569.170  
Nehrdajući čelik/  
staklo 750 mm

**1.289,00 KM**

**FUN:** 110.0439.951  
Nehrdajući čelik/  
staklo 900 mm

**1.339,00 KM**

**FUN:** 305.0625.239  
Crna mat/staklo  
600 mm

**1.339,00 KM**

**FUN:** 305.0625.238  
Crna mat/staklo  
900 mm

**1.449,00 KM**

### SISTEM ZA AUTOMATSKO AKTIVIRANJE KUHINJSKE NAPE

Senzor koji omogućuje samoaktivirajuće pokretanje kuhinjske nape, samo kada je to potrebno. Tako je omogućeno optimalno iskorištenje usisa nape i olakšan rad u kuhinji.

**Napomena:** Ova funkcija ne radi ispravno u kombinaciji s indukcijskim pločama. Napa se može automatski pokrenuti pri temperaturi prostorije višoj od 35°C.

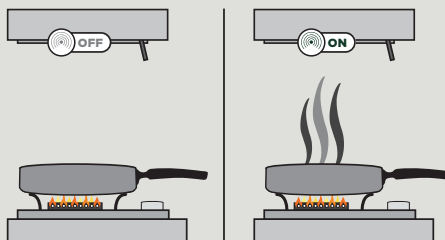

**A**  
ENERGY

**RAZINA  
BUKE  
dB(A)** INT  
69

**M<sup>3</sup>/H** INT  
670

**↔** 600 mm  
750 mm  
900 mm  
1200 mm



## IN-NOVA COMFORT



**FUN:** 110.0439.937  
Nehrdajući čelik 600 mm

**849,00 KM**

**FUN:** 110.0439.938  
Nehrdajući čelik 900 mm

**899,00 KM**



SOUND PRO



REMOTE BLOWER



LED LIGHT



C ENERGY



RAZINA BUKE dB(A) MAX 65



M<sup>3</sup>/H MAX 570



600 mm 900 mm

## IN-NOVA SMART



**FUN:** 305.0557.680  
Nehrdajući čelik 600 mm

**699,00 KM**

**FUN:** 305.0557.691  
Nehrdajući čelik 900 mm

**749,00 KM**



LED LIGHT



D ENERGY



RAZINA BUKE dB(A) MAX 68



M<sup>3</sup>/H MAX 360



600 mm 900 mm



## INKA LUX 3.0 PREMIUM



**FUN:** 305.0658.601  
Nehrdajući čelik K-LINK 520 mm

**1.599,00 KM**

**FUN:** 305.0658.607  
Nehrdajući čelik K-LINK 700 mm

**1.699,00 KM**

**FUN:** 305.0658.608  
Nehr. čelik/ crna mat K-LINK 520 mm

**1.699,00 KM**

**FUN:** 305.0658.609  
Nehr. čelik/ crna mat K-LINK 700 mm

**1.799,00 KM**



K-LINK



FABER CLOUD



SOUND PRO



REMOTE BLOWER (opcionažno)



PERIMETER ASPIRATION



INTENSIVE SPEED



FILTER ALARM



REMOTE CONTROL



TUNABLE WHITE



LED LIGHT



A ENERGY 700 mm



B ENERGY 520 mm



RAZINA BUKE dB(A) INT 68 (700 mm) 69 (520 mm)



M<sup>3</sup>/H INT 670 (520 mm) 720 (700 mm)



520 mm 700 mm

# UGRADBENE I TELESKOPSKE NAPE

## INKA LUX 3.0 EVO



**FUN:** 305.0665.353  
Nehrđajući čelik  
520 mm  
**899,00 KM**

**FUN:** 305.0665.354  
Nehrđajući čelik  
700 mm  
**999,00 KM**

**FUN:** 305.0665.357  
Nehr. čelik/ bijela mat  
520 mm  
**999,00 KM**

**FUN:** 305.0665.358  
Nehr. čelik/ bijela mat  
700 mm  
**1.099,00 KM**

**FUN:** 305.0665.355  
Nehr. čelik/ crna mat  
520 mm  
**999,00 KM**

**FUN:** 305.0665.356  
Nehr. čelik/ crna mat  
700 mm  
**1.099,00 KM**



**B** ENERGY

RAZINA BUKE dB(A) INT  
67 (520 mm)  
66 (700 mm)

M<sup>3</sup>/H INT  
620 (520 mm)  
670 (700 mm)

↔ 520 mm  
700 mm



## INKA LUX SMART



**FUN:** 305.0604.603  
Nehrđajući čelik 520 mm  
**719,00 KM**

**FUN:** 305.0604.604  
Nehrđajući čelik 700 mm  
**749,00 KM**



**B** ENERGY

RAZINA BUKE dB(A) BOOST  
68

M<sup>3</sup>/H BOOST  
690

↔ 520 mm  
700 mm

## INKA PLUS HCS



**FUN:** 305.0602.049  
Nehrđajući čelik  
520 mm  
**529,00 KM**

**FUN:** 305.0602.050  
Nehrđajući čelik  
700 mm  
**579,00 KM**

**FUN:** 305.0628.322  
Crna 520 mm  
**539,00 KM**

**FUN:** 305.0628.323  
Crna 700 mm  
**579,00 KM**



**B** ENERGY

RAZINA BUKE dB(A) MAX  
63

M<sup>3</sup>/H MAX  
590

↔ 520 mm  
700 mm

## INKA PLUS HC



**FUN:** 305.0602.047  
Nehrđajući čelik 520 mm  
**449,00 KM**

**FUN:** 305.0602.048  
Nehrđajući čelik 700 mm  
**489,00 KM**



**B** ENERGY

RAZINA BUKE dB(A) MAX  
63

M<sup>3</sup>/H MAX  
590

↔ 520 mm  
700 mm

## INKA SMART HCS



**FUN:** 305.0599.323  
Nehrđajući čelik 520 mm  
**419,00 KM**

**FUN:** 305.0599.321  
Nehrđajući čelik 700 mm  
**449,00 KM**



**B** ENERGY

RAZINA BUKE dB(A) MAX  
70

M<sup>3</sup>/H MAX  
390

↔ 520 mm  
700 mm

# UGRADBENE I TELESKOPSKE NAPE

## INKA SMART HC



LED LIGHT

**FUN:** 305.0599.307  
Nehrdajući čelik 520 mm

**339,00 KM**

**FUN:** 305.0599.308  
Nehrdajući čelik 700 mm

**379,00 KM**



B

ENERGY



RAZINA BUKE

dB(A)

MAX 70



M<sup>3</sup>/H

MAX 390



520 mm  
700 mm



INKA SMART C

## INKA SMART C



LED LIGHT

**FUN:** 305.0599.305  
Svijetlo siva 520 mm

**209,00 KM**

**FUN:** 305.0599.306  
Svijetlo siva 700 mm

**229,00 KM**

**FUN:** 305.0741.293  
Crna 520 mm\*

**239,00 KM**

**FUN:** 305.0741.292  
Crna 700 mm\*

**269,00 KM**



C

ENERGY



RAZINA BUKE

dB(A)

MAX 66



M<sup>3</sup>/H

MAX 335



520 mm  
700 mm

## MAXIMA TOUCH



SOUND PRO



REMOTE BLOWER (opcionally)



LED LIGHT

**FUN:** 315.0635.146  
Aluminij/ maska od nehrđajućeg čelika 600 mm

**699,00 KM**

**FUN:** 315.0635.147  
Aluminij/ maska od nehrđajućeg čelika 900 mm

**799,00 KM**



B

ENERGY



RAZINA BUKE

dB(A)

INT 66



M<sup>3</sup>/H

INT 740



600 mm  
900 mm

## MAXIMA ECO



REMOTE BLOWER (opcionally)



LED LIGHT

**FUN:** 315.0635.140  
Aluminij/ maska od nehrđajućeg čelika 600 mm

**549,00 KM**

**FUN:** 315.0635.143  
Aluminij/ maska od nehrđajućeg čelika 900 mm

**649,00 KM**



B

ENERGY



RAZINA BUKE

dB(A)

MAX 63



M<sup>3</sup>/H

MAX 620



600 mm  
900 mm

## FLEXA GLASS LUX



LED LIGHT

**FUN:** 315.0635.138  
Bijela / staklena maska 600 mm

**359,00 KM**

**FUN:** 315.0635.137  
Crna / staklena maska 600 mm

**359,00 KM**



D

ENERGY



RAZINA BUKE

dB(A)

MAX 69



M<sup>3</sup>/H

MAX 420



600 mm

## UGRADBENE I TELESKOPSKE NAPE

### FLEXA GLASS



LED LIGHT



**FUN:** 315.0635.107  
Bijela / staklena maska 600 mm

**269,00 KM**

**FUN:** 315.0635.106  
Crna / staklena maska 600 mm

**269,00 KM**



ENERGY



RAZINA BUKE

MAX 67



M<sup>3</sup>/H

MAX 310



600 mm

### FLEXA HIP



LED LIGHT



**FUN:** 315.0635.133  
Aluminij / maska od  
nehrđajućeg čelika 600 mm

**239,00 KM**

**FUN:** 315.0635.109  
Crna 600 mm

**259,00 KM**



ENERGY



RAZINA BUKE

MAX 69



M<sup>3</sup>/H

MAX 420



600 mm

### FLEXA



LED LIGHT



**FUN:** 315.0635.102  
Bijela / maska od  
nehrđajućeg čelika 600 mm

**189,00 KM**



ENERGY



RAZINA BUKE

MAX 69



M<sup>3</sup>/H

MAX 350



600 mm

### 152



LED LIGHT



**FUN:** 315.0547.802  
Svijetlo siva 600 mm

**199,00 KM**

**FUN:** 315.0547.803  
Svijetlo siva 900 mm

**224,00 KM**



ENERGY



RAZINA BUKE

MAX 68



M<sup>3</sup>/H

MAX 225



600 mm  
900 mm

## KLASIČNE NAPE

### 2740 PB

2

MOTORA



LED LIGHT



**FUN:** 300.0557.570  
Bijela 600 mm

**239,00 KM**

**FUN:** 300.0557.569  
Nehrđajući čelik 600 mm

**249,00 KM**



ENERGY



RAZINA BUKE

MAX 70



M<sup>3</sup>/H

MAX 380



600 mm

### 741 BASE



LED LIGHT



**FUN:** 300.0557.501  
Nehrđajući čelik  
500 mm\*

**169,00 KM**

**FUN:** 300.0557.500  
Bijela 500 mm\*

**129,00 KM**

**FUN:** 300.0557.508  
Smeđa/nehrđajući  
čelik 600 mm

**149,00 KM**

**FUN:** 300.0557.479  
Nehrđajući čelik  
600 mm

**169,00 KM**

**FUN:** 300.0557.477  
Bijela 600 mm

**129,00 KM**

**FUN:** 300.0557.499  
Smeđa 600 mm

**129,00 KM**



ENERGY



RAZINA BUKE

MAX 72



M<sup>3</sup>/H

MAX 305



500 mm  
600 mm

## DEKORATIVNE COUNTRY NAPE

### WEST

NOVO



Oblik okvira C2



Oblik okvira C3

FUN: 321.0693.744  
Bijela 900 mm  
**899,00 KM**



LED LIGHT

#### OKVIR / ZAVRŠNA OBRADA

FUN: 112.0693.760  
Okvir Ash 90 C3 **499,00 KM**



FUN: 112.0693.762  
Okvir Lime 90 C2 **499,00 KM**



FUN: 112.0693.764  
Okvir Lime 90 C3 **499,00 KM**



ENERGY



RAZINA BUKE dB(A)

MAX 67



M<sup>3</sup>/H

MAX 450



900 mm



### RANCH

NOVO



Oblik okvira C2



Oblik okvira C3

FUN: 321.0693.748  
Bijela 600 mm  
**699,00 KM**

FUN: 321.0693.747  
Bijela 900 mm  
**799,00 KM**

#### OKVIR 60 / ZAVRŠNA OBRADA

FUN: 112.0693.759  
Okvir Ash 60 C3 **499,00 KM**



FUN: 112.0693.761  
Okvir Lime 60 C2 **499,00 KM**



FUN: 112.0693.763  
Okvir Lime 60 C3 **499,00 KM**



#### OKVIR 90 / ZAVRŠNA OBRADA

FUN: 112.0693.760  
Okvir Ash 90 C3 **499,00 KM**



FUN: 112.0693.762  
Okvir Lime 90 C2 **499,00 KM**



FUN: 112.0693.764  
Okvir Lime 90 C3 **499,00 KM**



LED LIGHT



ENERGY



RAZINA BUKE dB(A)

MAX 67



M<sup>3</sup>/H

MAX 450



600 mm  
900 mm



### RANCH ANGOLO

NOVO



Oblik okvira C2



Oblik okvira C3

FUN: 321.0693.746  
Bijela 900 mm  
**1.099,00 KM**



LED LIGHT

#### OKVIR / ZAVRŠNA OBRADA

FUN: 112.0693.765  
Okvir Ash Angolo 90 C2



**599,00 KM**

FUN: 112.0693.766  
Okvir Ash Angolo 90 C3



**599,00 KM**



ENERGY



RAZINA BUKE dB(A)

MAX 67



M<sup>3</sup>/H

MAX 450



900 mm



# PRIBOR

# GALILEO

## SETOVI ZA UGRADNJU ZA MODELE:

Galileo NG, Galileo Smart i Galileo 60



Video s uputama

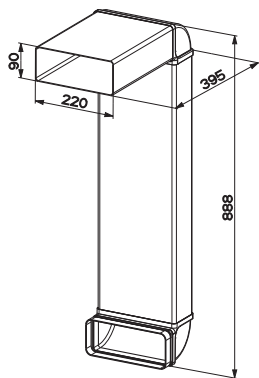

### ODVODNI SET PRIKLADAN ZA SVE GALILEO NAPE\*

#### Odvodni set

FUN 112.0540.782

- 1 x pravokutna cijev, 200 x 90 x 300 mm
- 2 x koljeno 90°, 220 x 90 mm
- 1 x pravokutna cijev, 200 x 90 x 700 mm
- 1 x adapter za cijev

269,00 KM

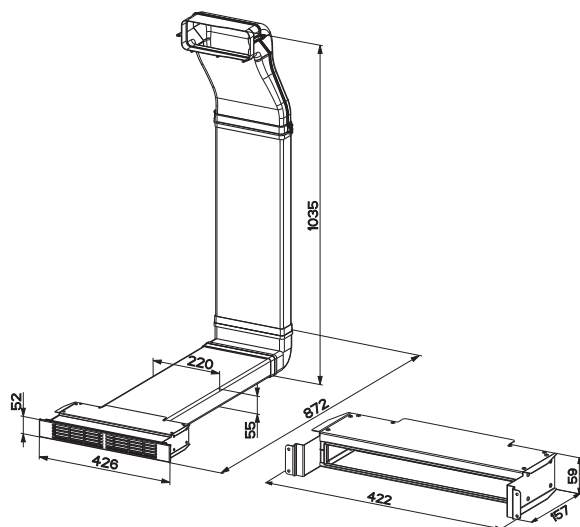

### ODVODNI SET GALILEO 60\*

#### Odvodni set za filtracijski mod H60

FUN 112.0626.656

- 2 x okomite spojnice (stražnja i prednja) za spajanje na motor
- 1 x spojnica s brtvom, 220 x 55 mm
- 2 x pravokutna cijev, 220 x 55 x 600 mm
- 1 x koljeno 90°, 220 x 55 mm
- Set za filtracijski mod H60

679,00 KM

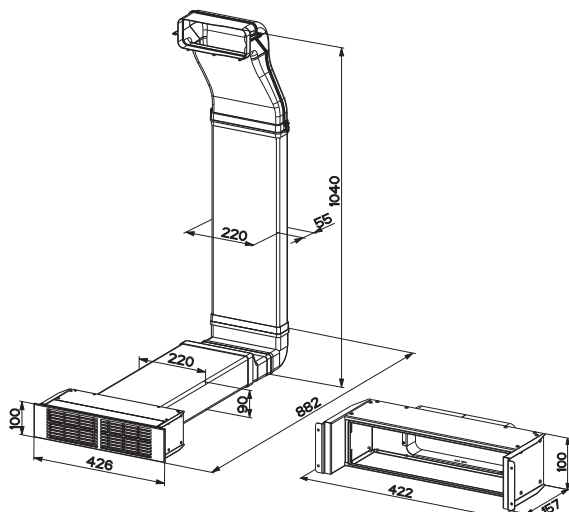

### ODVODNI SET GALILEO 60\*

#### Odvodni set za filtracijski mod H100

FUN 112.0626.657

- 2 x okomite spojnice (stražnja i prednja) za spajanje na motor
- 1 x spojnica s brtvom, 220 x 55 mm
- 1 x pravokutna cijev, 220 x 55 x 600 mm
- 1 x koljeno 90°, 220 x 55 mm
- 1 x pravokutna redukcija, 90-55 mm
- 1 x pravokutna spojnica, 200 x 90 mm
- 1 x pravokutna cijev, 220 x 90 x 500 mm
- Set za filtracijski mod H100

679,00 KM

## PLOČE S INTEGRIRANOM NAPOM.

Za ugradnju Galileo ploča za kuhanje s integriranom napom morat ćete kupiti odgovarajući komplet za ugradnju. Dostupni su različiti kompleti, ovisno o željenom modelu i konfiguraciji, usisnoj ili filtarskoj. Pojediniosti o svakom pojedinačnom kompletu, s komponentama uključenim u pakiranje, navedene su u nastavku.

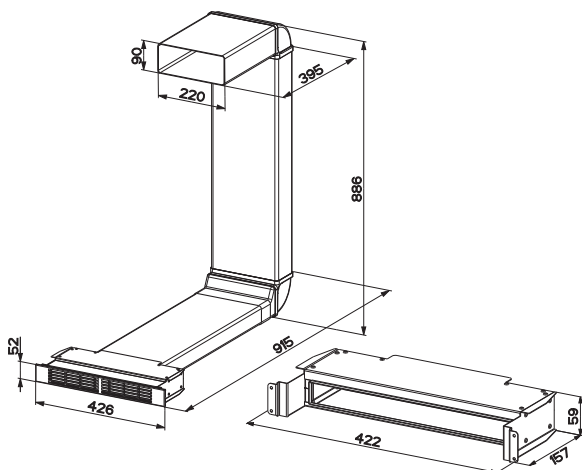

### ODVODNI SET GALILEO 80\*

**Odvodni set za filtracijski mod H60**  
FUN 112.0540.730

- 1 x pravokutna cijev, 200 x 90 x 300 mm
- 2 x koljeno 90°, 220 x 90 mm
- 1 x pravokutna cijev, 200 x 90 x 700 mm
- 1 x pravokutna redukcija, 90-55 mm
- 1 pravokutna cijev, 220 x 55 x 600 mm
- Set za filtracijski mod H60

939,00 KM

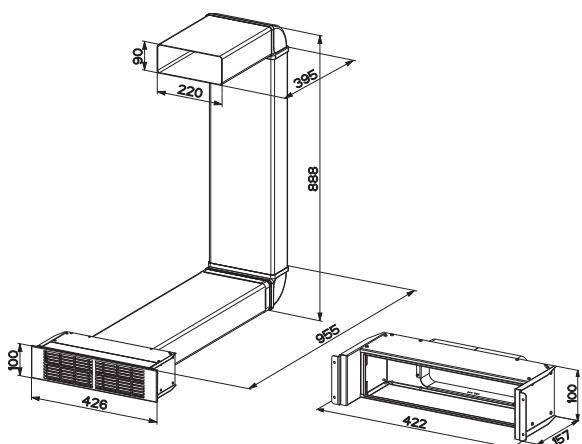

### ODVODNI SET GALILEO 80\*

**Odvodni set za filtracijski mod H100**  
FUN 112.0540.781

- 1 x pravokutna cijev, 200 x 90 x 300 mm
- 2 x koljeno 90°, 220 x 90 mm
- 2 x pravokutna cijev, 200 x 90 x 700 mm
- Set za filtracijski mod H100

939,00 KM

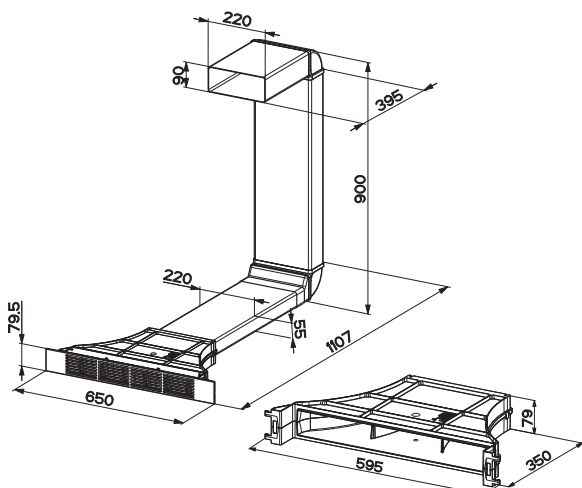

### ODVODNI SET GALILEO 80\*

**Long lasting H80 odvodni set za filtracijski mod**  
FUN 112.0605.735

- 1 x pravokutna cijev, 200 x 90 x 300 mm
- 2 x koljeno 90°, 220 x 90 mm
- 1 x pravokutna cijev, 200 x 90 x 700 mm
- 1 x pravokutna redukcija, 90-55 mm
- 1 pravokutna cijev, 220 x 55 x 600 mm
- LL H80 kit

489,00 KM

# GALILEO

## SETOVI ZA UGRADNJU ZA MODELE:



Video s uputama,  
ekstrakcijski mod



Video s uputama,  
filtracijski mod

### Galileo Stripes, Galileo Bold, Galileo Linear i Galileo Slim

Za ugradnju novih Galileo indukcijskih ploča s integriranom napom u ekstrakcijskom načinu rada potrebno je kupiti odgovarajući komplet za ugradnju.

Za filtracijski način rada, komplet sa stražnjim izlazom se standardno isporučuje sa uređajem, ali također je moguće odvod zraka postaviti u dno kuhinjskog elementa kupnjom odgovarajućeg seta za ugradnju.

Ispod su pojedini setovi o svakom pojedinačnom setu s popisom komponenti od kojih se sastoji.

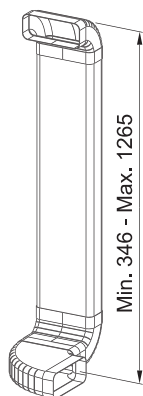

#### ODVODNI SET

##### Odvodni set za ekstrakcijski mod

FUN 112.0711.356

- 1 x 90° horizontalno koljeno
- 2 x 90° koljeno
- 1 x pravokutna cijev 220x90x1000
- 1 x ljepljiva traka

**335,00 KM**

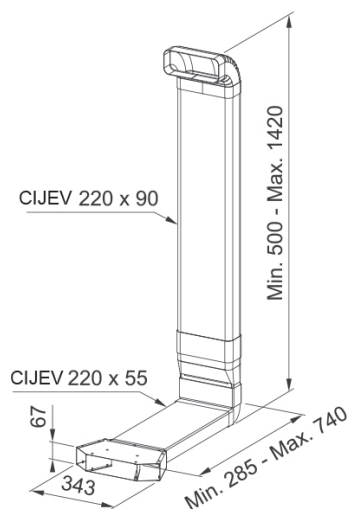

#### ODVODNI SET

##### Odvodni set za filtracijski mod/ visina cokla 70 mm

FUN 112.0711.987

- 1 x 90° koljeno 220x90
- 1 x spojnica difuzora zraka 220x55
- 1 x 90° koljeno 220x90
- 1 x pravokutna cijev 220x90x1000
- 1 x pravokutna spojnica 220x90
- 1 x ljepljiva traka
- 1 x pravokutna cijev 220x55x1000
- 1 x 90° koljeno 220x55
- 1 x pravokutna spojnica 220x55
- 1 x pravokutna spojnica 90-55
- 1 x difuzor zraka

**429,00 KM**

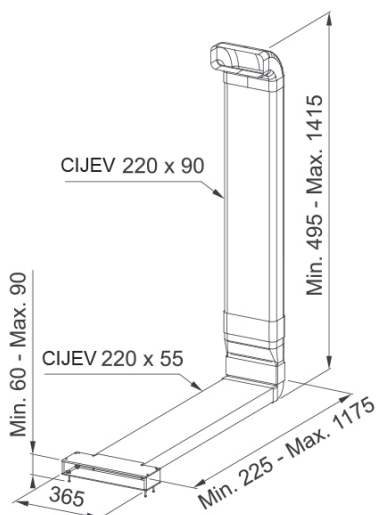

#### ODVODNI SET

##### Odvodni set za filtracijski mod/ visina cokla 60 mm

FUN 112.0711.988

- 1 x 90° koljeno 220x90
- 1 x 90° koljeno 220x90
- 1 x pravokutna cijev 220x90x1000
- 1 x pravokutna spojnica 220x90
- 1 x pravokutna spojnica 90-55
- 1 x pravokutna spojnica 220x55
- 1 x koljeno 220x55
- 1 x pravokutna cijev 220x55x1000
- 1 x difuzor zraka
- 1 x ljepljiva traka

**429,00 KM**

# GALILEO

## SET ZA FILTRACIJSKU VERZIJU I FILTERI ZA MODELE:



Video s uputama

### Galileo NG, Galileo Smart i Galileo 60



#### SET STRAŽNJEG FILTERA

**Set stražnjeg filtera**  
FUN 112.0685.046

- Galileo NG
- Galileo Smart
- Galileo
- Galileo 60

449,00 KM



#### KERAMIČKI FILTER

**Keramički filter H100**  
FUN 112.0548.448

- Galileo NG
- Galileo Smart
- Galileo
- Galileo 60

529,00 KM



#### KERAMIČKI FILTER

**Keramički filter H60**  
FUN 112.0548.447

- Galileo NG
- Galileo Smart
- Galileo
- Galileo 60

409,00 KM



#### LONG LASTING FILTER

**Long lasting filter H80**  
FUN 112.0605.736

- Galileo
- Galileo Smart

119,00 KM



#### LONG LASTING FILTER

**Long lasting stražnji filter HE**  
FUN 112.0684.122

- Galileo NG
- Galileo
- Galileo Smart
- Galileo 60

169,00 KM



## FILTER ZA MODELE:

### Galileo Stripes, Galileo Bold, Galileo Linear i Galileo Slim



Video s uputama,  
ekstrakcijski mod



Video s uputama,  
filtracijski mod



#### LONG LASTING FILTER

**Long lasting filter HE**  
FUN 112.0716.092

- Galileo Stripes
- Galileo Linear
- Galileo Bold
- Galileo Slim

229,00 KM

# GALILEO

## ODVODNI ELEMENTI ZA MODELE:

Galileo NG, Galileo Smart i Galileo 60



Video s uputama

PRAVOKUTNA CIJEV TR 1500 220X55X1500 MM FUN 112.0157.294

87,00 KM

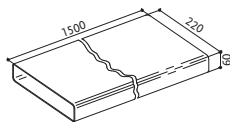

SPOJNICA RPR FUN 112.0157.297

20,00 KM

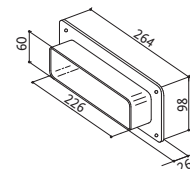

SPOJNICA RRC FUN 112.0157.296

40,00 KM

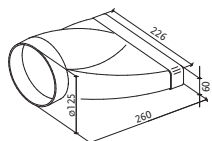

KOLJENO CRV 90 FUN 112.0157.299

25,00 KM

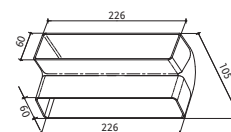

KOLJENO CRV 90 REVERZIBILNO FUN 112.0157.298

40,00 KM

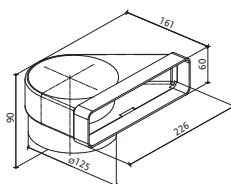

PRAVOKUTNA REDUKCIJA 60H FUN 112.0557.017

60,00 KM

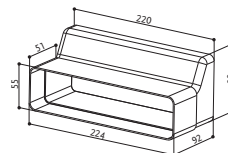

KOLJENO CRO 90 FUN 112.0157.300

46,00 KM

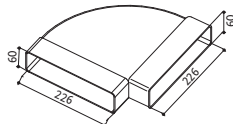

ROZETA GDC 125 FUN 112.0157.303

12,00 KM

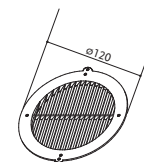

ROZETA GRE FUN 112.0157.304

22,00 KM

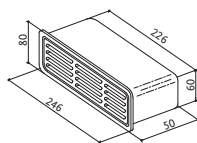

NOSAČ FRF FUN 112.0157.305

28,00 KM

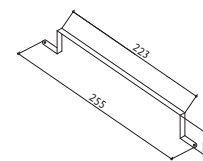

KOLJENO CRCO 90 REVERZIBILNO FUN 112.0157.306

49,00 KM

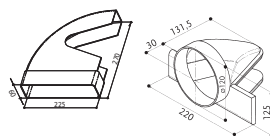

KOLJENO CC 90 FUN 112.0157.307

27,00 KM

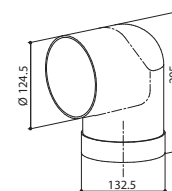

CIJEV TC 1000 FUN 112.0157.308

34,00 KM

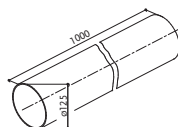

SPOJNICA 2 FR FUN 112.0157.309

13,00 KM

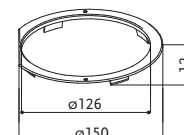

PRAVOKUTNA SPOJNICA FUN 112.0157.295

16,00 KM

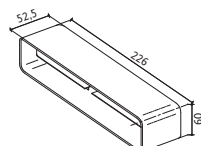

**PRAVOKUTNA CIJEV TR 1200 220X90 MM** FUN 112.0459.427

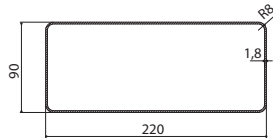
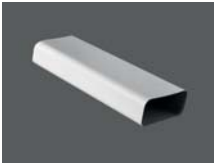

103,00 KM

**PRAVOKUTNA SPOJNICA 220X90 MM** FUN 112.0459.428

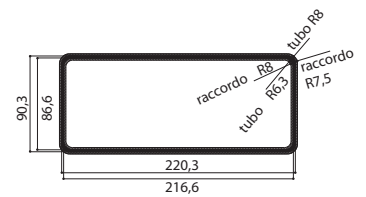

28,00 KM

**SPOJNICA RRC 220X90 MM** FUN 112.0459.429

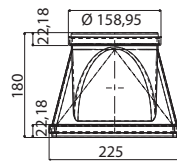

46,00 KM

**KOLJENO CRC 90 220X90 MM** FUN 112.0459.451

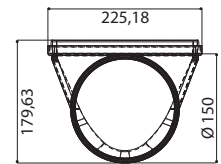

46,00 KM

**KOLJENO CRV 90 220X90 MM** FUN 112.0459.453

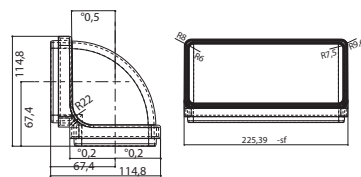

46,00 KM

**KOLJENO CRO 90 220X90 MM** FUN 112.0459.455

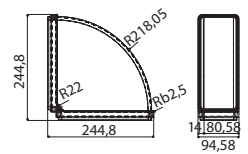

54,00 KM

**NOSAČ FRF 220X90 MM** FUN 112.0459.456

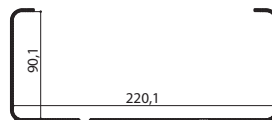

33,00 KM

**CIJEV TC 1000 Ø 150 MM** FUN 112.0253.681

46,00 KM

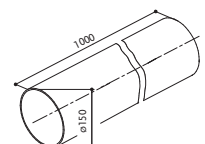

**FLEKSIBILNA SPOJNICA RF 600** FUN 112.0280.685

120,00 KM

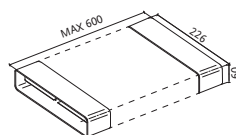

**OKRUGLA SPOJNICA D150** FUN 112.0253.690

31,00 KM

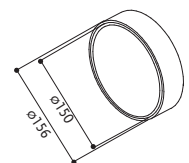

**KOLJENO TONDA 90° D150** FUN 112.0253.688

58,00 KM

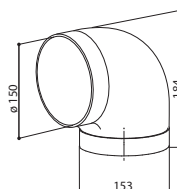

**REŠETKA 220X90** FUN 112.0605.516

80,73 KM

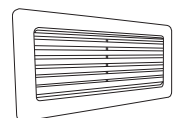

# GALILEO

## ODVODNI ELEMENTI ZA MODELE:



Video s uputama,  
ekstrakcijski mod



Video s uputama,  
filtracijski mod

### Galileo Stripes, Galileo Bold, Galileo Linear i Galileo Slim

FUN 112.0711.855

Spojnicica 90°, okruglo / pravkutno



79,00 KM

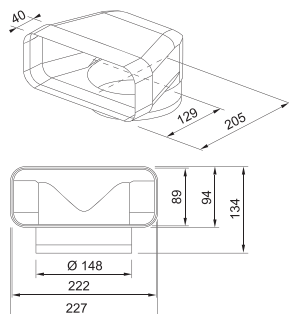

FUN 112.0711.860

Spojnicica za okruglu cijev



45,00 KM

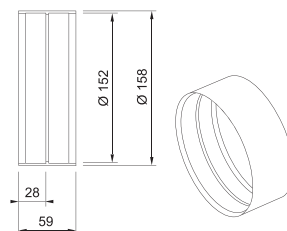

FUN 112.0711.856

Okrugla cijev Ø150 L=500 mm



69,00 KM

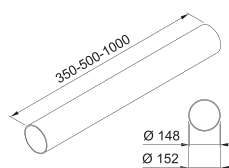

FUN 112.0711.852

Vertikalno koljeno 90° za pravokutnu cijev



89,00 KM

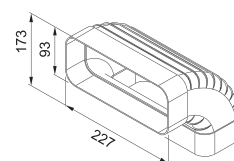

FUN 112.0711.858

Okrugla cijev Ø150 L=1000 mm



139,00 KM

FUN 112.0711.904

Spojnicica



69,00 KM

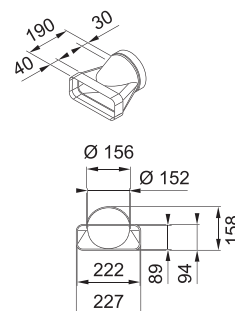

FUN 112.0711.853

Horizontalna spojnicica 90°



89,00 KM

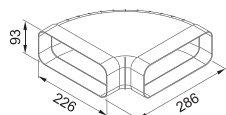

FUN 112.0711.854

Deflektor 90°



139,00 KM

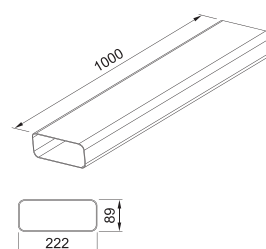

FUN 112.0711.901

Spojnicica 90° za okruglu cijev 150



109,00 KM

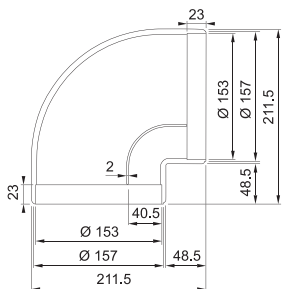

FUN 112.0711.905

Horizontalna spojnicica 15°



59,00 KM

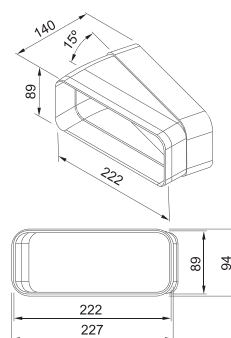

FUN 112.0711.902

Fleksibilna spojnicica 150



169,00 KM

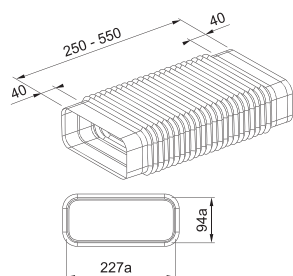

FUN 112.0711.905

Set za vanjski odvod za okruglu cijev



499,00 KM

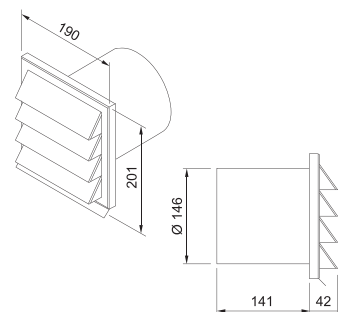

FUN 112.0711.903

Spojnicica za pravokutnu cijev



45,00 KM

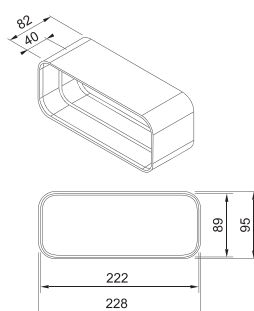

FUN 112.0711.906

Set za vanjski odvod za pravokutnu cijev



579,00 KM

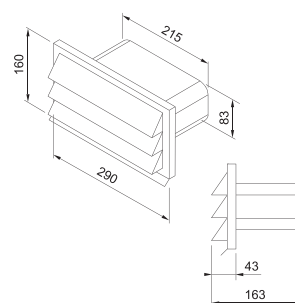

## CLIN&CLIN



**VLAŽNE MARAMICE (5 KOMADA)** FUN 112.0157.293

\*NAPOMENA  
Minimalna narudžba 30 komada ili količina djeljiva sa 30

**22,00 KM**

**REGENERACIJSKA PASTA 55 ml** FUN 112.0157.501

\*NAPOMENA  
Minimalna narudžba 10 komada ili količina djeljiva sa 10 (55 ml)

**26,00 KM**

**REGENERACIJSKA PASTA 200 ml** FUN 112.0157.502

\*NAPOMENA  
Minimalna narudžba 6 komada ili količina djeljiva sa 6 (200 ml).

**72,00 KM**

## KIT ZA FILTRACIJSKU IZVEDBU NAPE

**KIT POKLOPAC ODVODA VRT**  
FUN 112.0571.150

- VRT

**33,00 KM**

## SINTETIČKI FILTER

**SINTETIČKI FILTER - ROLA** FUN 112.0157.289

- Inka Smart  
- 152 LG  
- 741 Base  
- 2740 Base

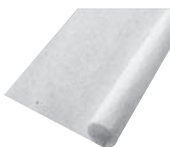

**30,00 KM**

## METALNI MODULARNI FILTERI

**METALNI FILTER 60** FUN 112.0157.248

**1 MOTOR**  
- 152 LG

**51,00 KM**

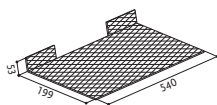

**METALNI FILTER 90** FUN 112.0157.249

**1 MOTOR**  
- 152 LG

**66,00 KM**

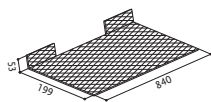

## KIT FILTERA INOX IN-NOVA

**KIT FILTERA INOX IN-NOVA 60** FUN 112.0624.485

**101,00 KM**

**KIT FILTERA INOX IN-NOVA 90** FUN 112.0624.486

**162,00 KM**

**KIT FILTERA INOX IN-NOVA 120** FUN 112.0624.487

**180,00 KM**

## UGLJENI FILTERI HIGH PERFORMANCE

**FHP8 HIGH PERFORMANCE (PAR)** FUN 112.0158.127

- Daisy Plus	- Inka Plus HC	- Tender
- Glam-Light	- Inka Plus HCS	- Tweet
- Glam Light	- Maxima Eco	- West
Zero Drip Plus	- Maxima Touch	
- Inka Lux 3.0	- Ranch	
Premium	- Steelmax	
- Inka Lux 3.0 Evo	- Strip Smart	
- Inka Lux Smart	- Strip Smart PB	



**201,00 KM**

## UGLJENI FILTERI LONG LASTING

**FLL3 UGLJENI FILTER LONG LASTING (PAR)** FUN 112.0544.470

- Flexa Glass Lux	- West
- Flexa Hip	- Ranch
- Value	- Ranch Angolo



**158,00 KM**

**FLL8 UGLJENI FILTER LONG LASTING D196 H37 (PAR)** FUN 112.0185.278

- Daisy Plus	- Inka Plus HCS
- Glam-Light	- Maxima Eco
- Glam Light Zero	- Maxima Touch
Drip Plus	- Steelmax
- Inka Lux 3.0	- Strip Smart
Premium	- Strip Smart PB
- Inka Lux 3.0 Evo	- Tender
- Inka Lux Smart	- Tweet
- Inka Plus HC	



**275,00 KM**

**FLL23 UGLJENI FILTER D125** FUN 112.0556.528

- Inka Smart C
- Inka Smart HCS
- Inka Smart HC
- Flexa
- Flexa Glass

**93,00 KM****FLL9 UGLJENI FILTER LONG LASTING EASY CUBE** FUN 112.0185.276

- Cylindra
- Cylindra Isola
- Cylindra Gloss Plus
- Cylindra Isola Gloss Plus
- Eclipse
- Glassy Isola
- In-Nova Premium
- Stilo Comfort
- Stilo Comfort Isola
- Stilo Glass Smart Isola
- Stilo Smart

**207,00 KM****F26 UGLJENI FILTER** FUN 112.0627.248

- In-Nova Zero Drip

**90,00 KM**

## FILTERI S AKTIVNIM UGLJENOM

**F23 UGLJENI FILTER D125** FUN 112.0556.527

- Inka Smart C
- Inka Smart HC
- Inka Smart HCS
- Flexa
- Flexa Glass

**42,00 KM****F24 UGLJENI FILTER NAUTILUS L** FUN 112.0571.379

- 741 Base

**25,00 KM****F1 UGLJENI FILTER** FUN 112.0157.238

- 1 MOTOR - 1 blower
- 152
- 2 MOTORA - 2 blowers
- 2740 PB

Za nape sa 2 motora potrebna su 2 filtera

**25,00 KM****F3 UGLJENI FILTER (PAR)** FUN 112.0067.944

- Flexa Glass Lux
- Flexa Hip
- Value
- West
- Ranch
- Ranch Angolo

**32,00 KM****F4-14B UGLJENI FILTER 195x139 (PAR)** FUN 112.0441.093

- In-Nova Comfort
- In-Nova Smart

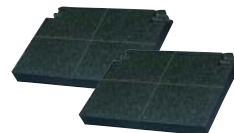
**106,00 KM****F8 UGLJENI FILTER D196 H37 (PAR)** FUN 112.0157.240

- Daisy Plus
- Glam-Light
- Glam Light
- Zero Drip Plus
- Inka Lux 3.0
- Premium
- Inka Lux 3.0 Evo
- Inka Lux Smart
- Inka Plus HC
- Inka Plus HCS
- Maxima Eco
- Maxima Touch
- Ranch
- Steelmax
- Strip Smart
- Strip Smart PB
- Tender
- Tweet
- West

**61,00 KM****F9 UGLJENI FILTER** FUN 112.0157.243

- Cylindra
- Cylindra Isola
- Cylindra Gloss Plus
- Cylindra Isola Gloss Plus
- Eclipse
- Glassy Isola
- In-Nova Premium
- In-Nova Zero Drip
- Stilo Angolo
- Stilo Comfort
- Stilo Comfort Isola
- Stilo Glass Smart Isola
- Stilo Smart

**72,00 KM****UGLJENI FILTER VRT** FUN 112.0569.559

- VRT

**37,00 KM**

# ODVODNI ELEMENTI Ø 100 mm

## NEPOVRATNI VENTIL D100 FUN 112.0572.297

Nepovratni ventil okrugli



82,00 KM

# ODVODNI ELEMENTI Ø 120 mm

## CIJEV TR 1500 FUN 112.0157.294

Pravokutna cijev  
TR 1500  
220x55x1500 mm

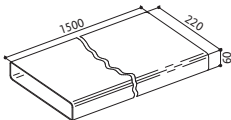

87,00 KM

## SPOJNICA RRC FUN 112.0157.296

Koljeno  
pravokutno/okruglo

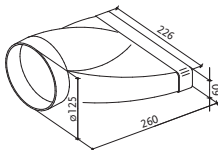

40,00 KM

## KOLJENO CRCV 90 REVERZIBILNO FUN 112.0157.298

Koljeno  
okruglo/pravokutno  
90° reverzibilna

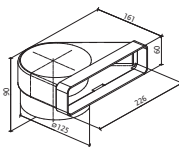

40,00 KM

## KOLJENO CRO 90 FUN 112.0157.300

Koljeno pravokutno/  
pravokutno 90°  
horizontalna

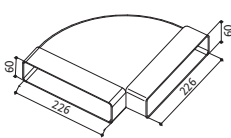

46,00 KM

## REDUKCIJA RC 125-100 FUN 112.0157.302

Redukcija 125-100/  
okrugla

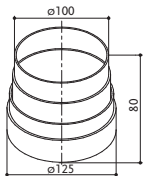

12,00 KM

## ROZETA GRE FUN 112.0157.304

Pravokutna rozeta  
vanjska

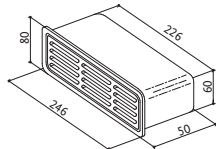

22,00 KM

## KOLJENO CRCO 90 REVERZIBILN FUN 112.0157.306

Koljeno  
pravokutno/  
okrugla 90°  
horizontalno  
reverzibilna

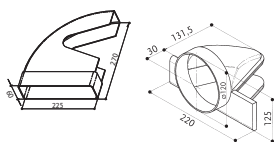

49,00 KM

## SPOJNICA RCR FUN 112.0157.295

Spojnicija cijevi

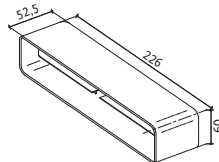

16,00 KM

## SPOJNICA RPR FUN 112.0157.297

Zidna spojnicija -  
pravokutna

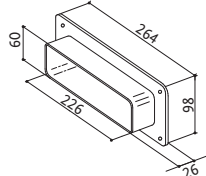

20,00 KM

## KOLJENO CRV 90 FUN 112.0157.299

Koljeno  
pravokutno/  
pravokutno 90°

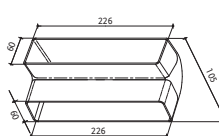

25,00 KM

## FLEKSIBILNO CRIJEVO TCF 130 FUN 112.0157.301

Fleksibilno crijevo  
L = 1,5 m Ø 130 mm

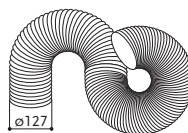

34,00 KM

## ROZETA GDC 125 FUN 112.0157.303

Rozeta okrugla vanjska

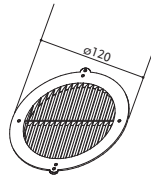

12,00 KM

## NOSAČ CIJEVI FRF FUN 112.0157.305

Nosač za cijev

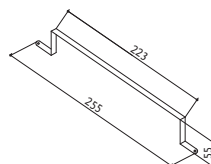

28,00 KM

## KOLJENO CC 90 FUN 112.0157.307

Koljeno okruglo 90°  
Ø 125 mm

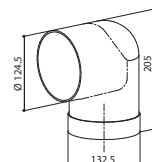

27,00 KM

## CIJEV TC 1000 FUN 112.0157.308

Cijev okrugla TC 1000

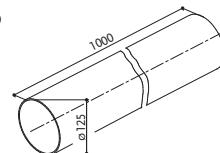

34,00 KM

## SPOJNICA 2 FR FUN 112.0157.309

Završnica okrugla

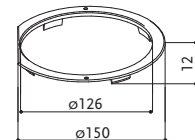

13,00 KM

## VENTIL VR2 120 FUN 112.0189.216

Nepovratni ventil okrugli



15,00 KM

## OBJUMICA 2FCR FUN 112.0169.119

Objumica za spajanje cijevi



11,00 KM

## SPOJNICA RR 90/55

6098004  
Spojna redukcija  
pravokutno/pravokutno  
90/55 DX

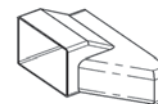

26,00 KM

6098015  
Spojna redukcija pravokutno/pravokutno 90/55 LX

26,00 KM

## NEPOVRATNI VENTIL D120 FUN 112.0189.207

Nepovratni ventil



17,00 KM

# ODVODNI ELEMENTI Ø 125 mm

## NEPOVRATNI VENTIL 3D D125 FUN 112.0569.782

Nepovratni ventil okrugli



185,00 KM

## HERMETIČKI KANALNI VENTIL D125 FUN 112.0569.784

Hermetički kanalni ventil



799,00 KM

# ODVODNI ELEMENTI Ø 150 mm

## CIJEV D150 1000 FUN 112.0253.681

Cijev okrugla TC 1000  
Ø 150 mm

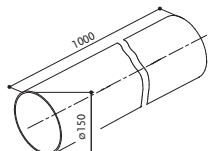

46,00 KM

## KOLJENO 90° D150 FUN 112.0253.688

Koljeno okruglo 90°  
Ø 150 mm

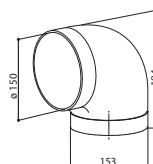

58,00 KM

## CIJEV TCF 150 L=1,5 M. FUN 112.0280.687

Fleksibilno crijevo

L = 1,5 m Ø 150 mm

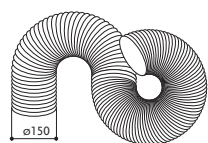

43,00 KM

## CIJEV TR 1200 220x90 FUN 112.0459.427

Cijev pravokutna  
TR 1200  
220x90 mm

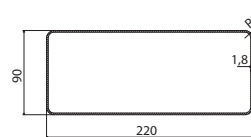

103,00 KM

## OKRUGLA SPOJNICA D150 FUN 112.0253.690

Okrugla spojnica  
Ø 150 mm

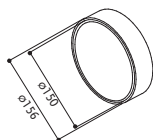

31,00 KM

## SPOJNICA RRC 220x90 FUN 112.0459.429

Spojnica  
okruglo/pravokutno  
220x90 mm

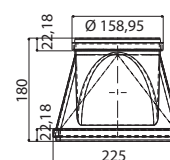

46,00 KM

## SPOJNICA RCR 220x90 FUN 112.0459.428

Spojnica pravokutna  
220x90 mm

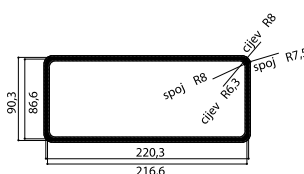

28,00 KM

## KOLJENO CRV 90 220x90 FUN 112.0459.453

Koljeno  
okruglo/  
pravokutno 90°  
220x90 mm

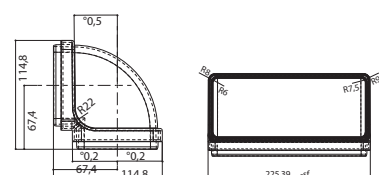

46,00 KM

## KOLJENO CRC 90 220x90 FUN 112.0459.451

Koljeno  
okruglo/pravokutno  
90°  
220x90 mm

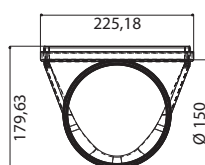

46,00 KM

## NOSAČ CIJEVI FRF 220x90 FUN 112.0459.456

Nosač za cijev  
220x90 mm

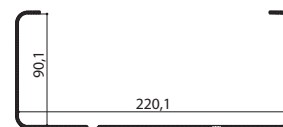

18,99 KM

## KOLJENO CRO 90 220x90 FUN 112.0459.455

Koljeno  
pravokutno/pravokutno  
90° horizontalna 220x90 mm

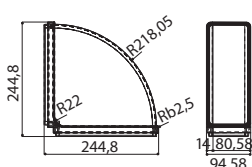

54,00 KM

## NEPOVRATNI VENTIL 3D D150 FUN 112.0569.781

Nepovratni ventil



200,00 KM

## VENTIL D150 FUN 112.0086.450

Ventil



25,00 KM

## HERMETIČKI KANALNI VENTIL D150 FUN 112.0569.783

Hermetički kanalni ventil

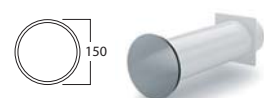

799,00 KM

Pravokutna fleksibilna  
spojnica

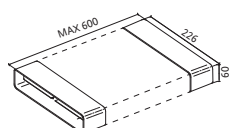

120,00 KM

# UGRADNJA

**Pravilna ugradnja započinje izvidom. Pri odabiru morate znati:**

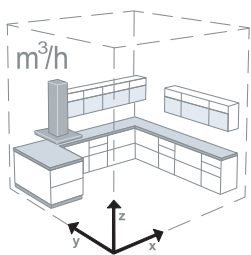

Zapreminu kuhinje (o kojoj ovisi potreban kapacitet nape). Pogledati odjeljak "Odaberite odgovarajuću napu".

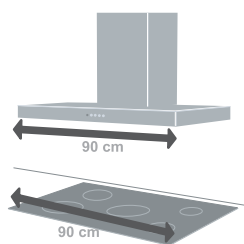

Duljinu ploče za kuhanje (napa bi, u pravilu, trebala biti dugačka barem koliko i ploča za kuhanje).

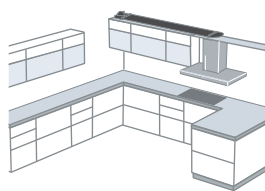

Pozicija i udaljenost otvora odvoda od ploče za kuhanje (vrlo duge cijevi i velik broj koljena bitno ograničavaju učinkovitost nape).

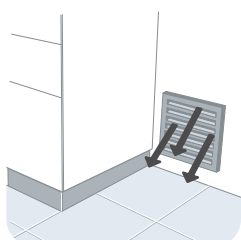
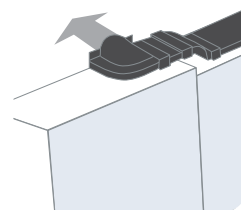

Po standardu potrebna su dva otvora na vanjskom zidu, uz odgovarajuću opremu:

1. ulazni otvor za prozračivanje prostorije izvana, načinjen na nižem dijelu zida.
2. izlazni otvor za izbacivanje dima iz prostorije, načinjen na višem dijelu zida (ili u dimnjaku predviđenom isključivo u ovu svrhu).

Kod usisne verzije nape, izlazni otvor služi kao krajnji vod sustava izbacivanja zraka.

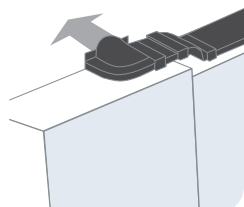

**Ispravnost proizvoda**

- Nakon otvaranja, provjerite ispravnost uređaja.
- Provjerite je li uređaj kompletni i neoštećen prilikom transporta.
- Uređaj mora biti dostavljen s jamstvom ili uputama za uporabu.

**NAPOMENA:** Ne montirajte oštećeni uređaj. Oštećeni uređaj zamijenite bez naknade. U protivnom, morat ćete snositi troškove servisiranja. Prije montaže nemojte skidati zaštitnu foliju.

## Udaljenost nape od ploče za kuhanje

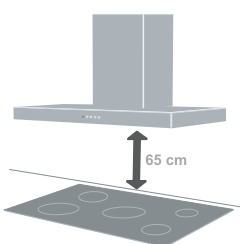

Za učinkovitiji rad nape, savjetujemo ugradnju na visini koja ne prelazi 75 cm iznad ploče za kuhanje. Najmanja udaljenost od ploče za kuhanje iznosi 65 cm.

**NAPOMENA:** jamstvo ne pokriva eventualne štete nastale uslijed nepoštivanja najmanje sigurnosne udaljenosti. Odvod kuhinjskih para mora biti što je moguće bliže napi i preporučuje se odvodni kanal promjera 15 cm (nikako manje od 12 cm), za dužine koje ne prelaze 3-4 m uz najviše 2 koljena.

Neke nape koje se montiraju vertikalno (Mirror, Matrix) potrebno je instalirati niže. Provjerite tehničku dokumentaciju proizvoda.

## Provjera

- 1 - Uključite motor uređaja
- 2 - Uključite rasvjetu

Kod ekstrakcijske verzije nape, provjerite je li pravilno spojena na izlazni sustav cijevi. Kod filtracijske verzije nape, provjerite jesu li postavljeni filteri s aktivnim ugljenom.

## Prvo čišćenje

- Skinite zaštitnu foliju
  - Uklonite nečistoće pomoću vlažne spužve i malo neutralnog sredstva za čišćenje
  - Isperite vlažnom krpom
  - Posušite mekanom krpom.
- Ukoliko je napa izrađena od nehrđajućeg čelika, potrebno ju je ispolirati. Napu od nehrđajućeg čelika možete zaštititi uporabom Faber Clin&Clin maramica



**Faber nape jednostavno je instalirati zahvaljujući sistemu EASY CUBE:**

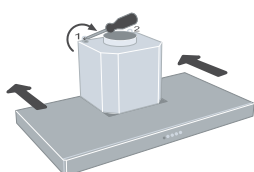

Objesite napu na nosač

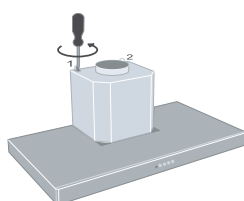

Nivelirajte napu

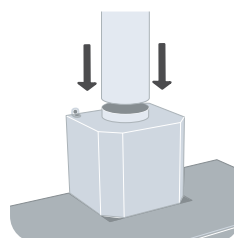

Spojite odvodne cijevi

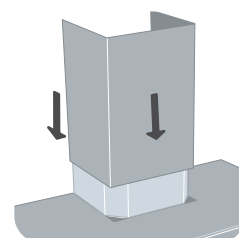

Montirajte ukrasni dimnjak



**FRANKE**

Kolekcija 2025

# Korita od nehrđajućeg



# čelika



**MARIS - MRX 210-34** - poravnana i poluporavnana ugradnja

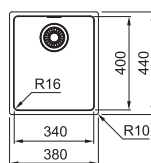
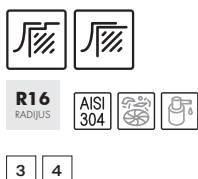

3 4

**569,00 KM**

**Završna obrada**

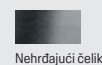

Nehrdajući čelik

**FUN broj**

127.0531.915

**Ormar**

450 mm

**Dimenzije Š x D**

380 x 440 mm

**Ugradni otvor Š x D**

vidi uputu

**Dubina korita**

180 mm

**Rub**

slim top

**MARIS - MRX 210-40** - poravnana i poluporavnana ugradnja

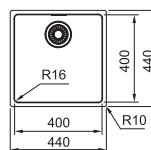
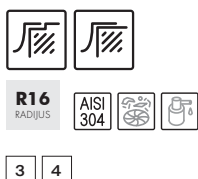

3 4

**619,00 KM**

**Završna obrada**

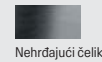

Nehrdajući čelik

**FUN broj**

127.0531.809

**Ormar**

500 mm

**Dimenzije Š x D**

440 x 440 mm

**Ugradni otvor Š x D**

vidi uputu

**Dubina korita**

180 mm

**Rub**

slim top

**MARIS - MRX 210-40 TL** - poravnana i poluporavnana ugradnja

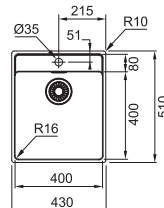
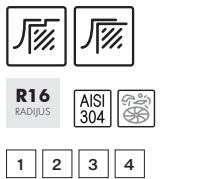

1 2 3 4

**769,00 KM**

**Završna obrada**

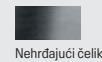

Nehrdajući čelik

**FUN broj**

127.0531.851

**Ormar**

500 mm

**Dimenzije Š x D**

430 x 510 mm

**Ugradni otvor Š x D**

vidi uputu

**Dubina korita**

180 mm

**Rub**

slim top

**MARIS - poravnana i poluporavnana ugradnja**



1  
112.0520.471  
Ploča za rezanje



2  
112.0520.497  
Cjedilo inox sa dodatkom



3  
112.0030.882  
Rollmat podloška

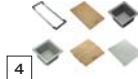

4  
ALL-IN-ONE setovi

**MARIS - MRX 210-45** - poravnana i poluporavnana ugradnja

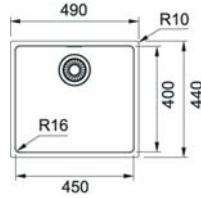

**719,00 KM**

<b>Završna obrada</b>	<b>FUN broj</b>
Nehrđajući čelik	127.0553.961
<b>Ormar</b>	<b>500 mm</b>
<b>Dimenzije Š x D</b>	<b>490 x 440 mm</b>
<b>Ugradni otvor Š x D</b>	<b>vidi uputu</b>
<b>Dubina korita</b>	<b>180 mm</b>
<b>Rub</b>	<b>slim top</b>

**MARIS - MRX 210-50** - poravnana i poluporavnana ugradnja

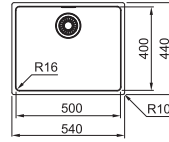
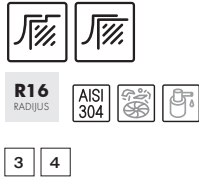

**769,00 KM**

<b>Završna obrada</b>	<b>FUN broj</b>
Nehrđajući čelik	127.0531.810
<b>Ormar</b>	<b>600 mm</b>
<b>Dimenzije Š x D</b>	<b>540 x 440 mm</b>
<b>Ugradni otvor Š x D</b>	<b>vidi uputu</b>
<b>Dubina korita</b>	<b>180 mm</b>
<b>Rub</b>	<b>slim top</b>

**MARIS - MRX 210-50 TL** - poravnana i poluporavnana ugradnja

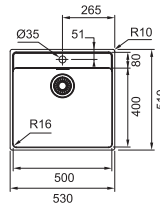

**879,00 KM**

<b>Završna obrada</b>	<b>FUN broj</b>
Nehrđajući čelik	127.0531.852
<b>Ormar</b>	<b>600 mm</b>
<b>Dimenzije Š x D</b>	<b>530 x 510 mm</b>
<b>Ugradni otvor Š x D</b>	<b>vidi uputu</b>
<b>Dubina korita</b>	<b>180 mm</b>
<b>Rub</b>	<b>slim top</b>

**MARIS - MRX 110-45** - ugradnja pod radnu ploču

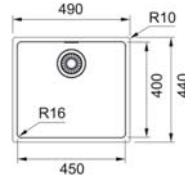
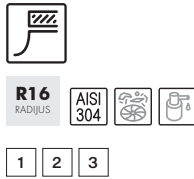

**629,00 KM**

<b>Završna obrada</b>	<b>FUN broj</b>
Nehrđajući čelik	122.0553.943
<b>Ormar</b>	<b>550 mm</b>
<b>Dimenzije Š x D</b>	<b>490 x 440 mm</b>
<b>Ugradni otvor Š x D</b>	<b>vidi uputu</b>
<b>Dubina korita</b>	<b>180 mm</b>
<b>Rub</b>	<b>-</b>

**MARIS - MRX 110-50** - ugradnja pod radnu ploču

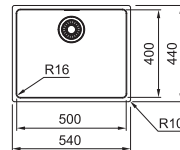
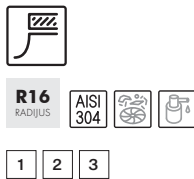

**659,00 KM**

<b>Završna obrada</b>	<b>FUN broj</b>
Nehrđajući čelik	122.0531.808
<b>Ormar</b>	<b>550 mm</b>
<b>Dimenzije Š x D</b>	<b>540 x 440 mm</b>
<b>Ugradni otvor Š x D</b>	<b>vidi uputu</b>
<b>Dubina korita</b>	<b>180 mm</b>
<b>Rub</b>	<b>-</b>

**MARIS - MRX 110-55** - ugradnja pod radnu ploču

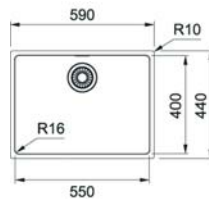
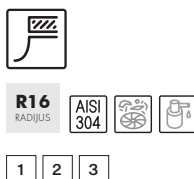

**719,00 KM**

<b>Završna obrada</b>	<b>FUN broj</b>
Nehrđajući čelik	122.0553.947
<b>Ormar</b>	<b>800 mm</b>
<b>Dimenzije Š x D</b>	<b>590 x 440 mm</b>
<b>Ugradni otvor Š x D</b>	<b>vidi uputu</b>
<b>Dubina korita</b>	<b>180 mm</b>
<b>Rub</b>	<b>-</b>

**MARIS - poravnana i poluporavnana ugradnja**

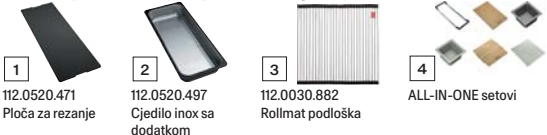

**MARIS - ugradnja pod radnu ploču**





## ATON - ANX 110-34 - ugradnja pod radnu ploču



**R36**

RADIJUS

**AISI 304**



1 2 3

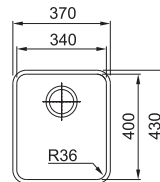

**369,00 KM**

### Završna obrada



Nehrdajući čelik

### FUN broj

122.0204.647

### Ormar

450 mm

### Dimenzije Š x D

370 x 430 mm

### Ugradni otvor Š x D

vidi uputu

### Dubina korita

190 mm

### Rub

-

## ATON - ANX 110-48 - ugradnja pod radnu ploču



**R36**

RADIJUS

**AISI 304**



1 2 3

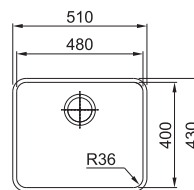

**419,00 KM**

### Završna obrada



Nehrdajući čelik

### FUN broj

122.0204.649

### Ormar

600 mm

### Dimenzije Š x D

510 x 430 mm

### Ugradni otvor Š x D

vidi uputu

### Dubina korita

190 mm

### Rub

-

## ATON

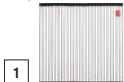

1  
112.0030.882  
Rollmat podloška



2  
112.0057.850  
Kadica/cjedilo inox

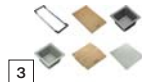

3  
ALL-IN-ONE setovi

# Sottotop



Fotografija je simbolična.  
Ovaj model sudopera nije u ponudi.

## SOTTOTOP - GAX 110-30 - ugradnja pod radnu ploču



1

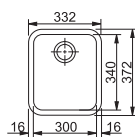

279,00 KM

### Završna obrada



Nehrdajući čelik

### FUN broj

122.0021.439

### Ormar

400 mm

### Dimenzije Š x D

332 x 372 mm

### Ugradni otvor Š x D

vidi uputu

### Dubina korita

170 mm

### Rub

-

## SOTTOTOP - SVX 110-40 - ugradnja pod radnu ploču



1

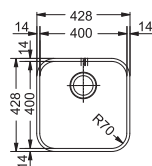

319,00 KM

### Završna obrada



Nehrdajući čelik

### FUN broj

122.0039.092

### Ormar

600 mm

### Dimenzije Š x D

428 x 428 mm

### Ugradni otvor Š x D

vidi uputu

### Dubina korita

190 mm

### Rub

-

## SOTTOTOP - GAX 110-45 - ugradnja pod radnu ploču



1

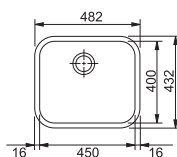

329,00 KM

### Završna obrada



Nehrdajući čelik

### FUN broj

122.0021.440

### Ormar

600 mm

### Dimenzije Š x D

482 x 432 mm

### Ugradni otvor Š x D

vidi uputu

### Dubina korita

190 mm

### Rub

-



**SMART - SRX 210-40 TL** - poravnana i poluporavnana ugradnja



1

**359,00 KM**

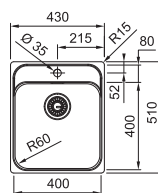

**Završna obrada**

 Nehrđajući čelik

**FUN broj**

127.0704.666

**Ormar**

500 mm

**Dimenzije Š x D**

430 x 510 mm

**Ugradni otvor Š x D**

vidi uputu

**Dubina korita**

171 mm

**Rub**

-

**SMART - SRX 210-50 TL** - poravnana i poluporavnana ugradnja



1

**399,00 KM**

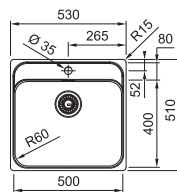

**Završna obrada**

 Nehrđajući čelik

**FUN broj**

127.0704.667

**Ormar**

600 mm

**Dimenzije Š x D**

530 x 510 mm

**Ugradni otvor Š x D**

vidi uputu

**Dubina korita**

171 mm

**Rub**

-

**SMART**



1

ALL-IN-ONE setovi

# Bell



BELL - BCX 610-51 - standardna ugradnja



AISI 304

1

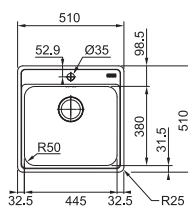

299,00 KM

Završna obrada

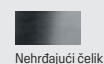

Nehrđajući čelik

FUN broj

101.0622.893

Ormar

600 mm

Dimenzije Š x D

510 x 510 mm

Ugradni otvor Š x D

486 x 486 mm (R10-20)

Dubina korita

200 mm

Rub

standard

BELL - BCX 610-81 - standardna ugradnja



AISI 304

1

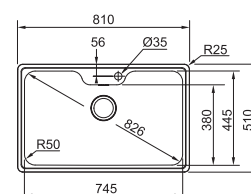

549,00 KM

Završna obrada

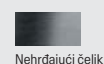

Nehrđajući čelik

FUN broj

101.0693.352

Ormar

900 mm

Dimenzije Š x D

810 x 510 mm

Ugradni otvor Š x D

788 x 488 mm (R10-20)

Dubina korita

200 mm

Rub

standard

BELL

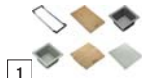

1

ALL-IN-ONE setovi

# Spark



Fotografija je simbolična.  
Ovaj model sudopera nije u ponudi.

SPARK - SKN 610-37 - standardna ugradnja



NOVO



1

149,00 KM

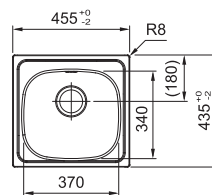

Sudoperi se isporučuju bez kartonske kutije u kompletu s odvodnim elementima i sifonom.

#### Završna obrada

 Nehrđajući čelik

#### FUN broj

101.0708.052

#### Ormar

450 mm

#### Dimenzije Š x D

455 x 435 mm

#### Ugradni otvor Š x D

435 x 415 mm

#### Dubina korita

150 mm

#### Rub

standard

# Rotondo



Fotografija je simbolična.  
Ovaj model sudopera nije u ponudi.

ROTONDO - ROX 610-39 - standardna ugradnja



NOVO



199,00 KM

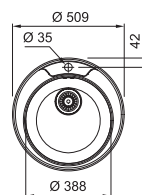

#### Završna obrada

 Nehrđajući čelik

#### FUN broj

101.0714.034

#### Ormar

450 mm

#### Dimenzije Ø

510 mm

#### Ugradni otvor Ø

490 mm

#### Dubina korita

170 mm

#### Rub

slim

#### SPARK



1

ALL-IN-ONE setovi

# Sudoperi od nehrđajućeg



# čelika



SMART - SRX 611-86 - standardna ugradnja



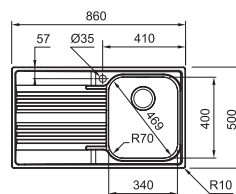

329,00 KM



Završna obrada

■  
Nehrdajući čelik

FUN broj

101.0356.758   
101.0356.759 

Ormar

Dimenzije Š x D

Ugradni otvor Š x D

Dubina korita

Rub

450 mm (600 završni)

860 x 500 mm

840 x 480 mm

200 mm

slim

SMART - SRX 611-86 LB - standardna ugradnja



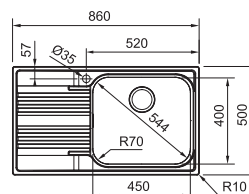

369,00 KM



Završna obrada

■  
Nehrdajući čelik

FUN broj

101.0356.849   
101.0356.850 

Ormar

Dimenzije Š x D

Ugradni otvor Š x D

Dubina korita

Rub

600 mm

860 x 500 mm

840 x 480 mm

200 mm

slim

SMART

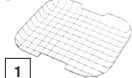

1  
112.0049.608  
Rešetka inox



2  
112.0057.850  
Kadica/cjedilo inox

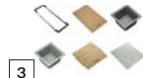

3  
ALL-IN-ONE setovi

# Logica Line



LOGICA LINE - LLX 611 - standardna ugradnja



AISI 304



TIS

Tis podupirač slavine u kompletu

1 2 4

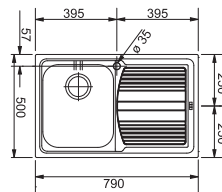

299,00 KM

Završna obrada



Nehrdajući čelik

FUN broj

101.0152.578



101.0152.582



Ormar

450 mm

Dimenzije Š x D

790 x 500 mm

Ugradni otvor Š x D

770 x 480 mm

Dubina korita

195 mm

Rub

slim

LOGICA LINE - LLX 611-L - standardna ugradnja



AISI 304



TIS

Tis podupirač slavine u kompletu

1 2 4

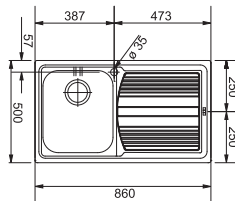

299,00 KM

Završna obrada



Nehrdajući čelik

FUN broj

101.0152.583



101.0152.585



Ormar

450 mm

Dimenzije Š x D

860 x 500 mm

Ugradni otvor Š x D

840 x 480 mm

Dubina korita

195 mm

Rub

slim

LOGICA LINE



1  
112.0595.334  
Daska za rezanje

2  
112.0057.850  
Kadica/cjedilo inox

3  
112.0040.691  
Kadica inox

4  
ALL-IN-ONE setovi

# Spark



SPARK - SKN 611-62 - standardna ugradnja



NOVO

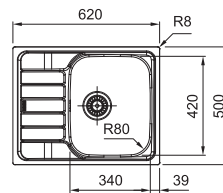

199,00 KM

Završna obrada

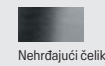

Nehrdajući čelik

FUN broj

101.0717.455



Ormar

Dimenzije Š x D

Ugradni otvor Š x D

Dubina korita

Rub

450 mm

620 x 435 mm

600 x 415 mm

150 mm

standard

SPARK - SKX 611-78 - standardna ugradnja



NOVO

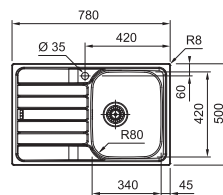

239,00 KM

Završna obrada

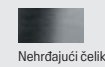

Nehrdajući čelik

FUN broj

101.0712.130



101.0712.129



Ormar

Dimenzije Š x D

Ugradni otvor Š x D

Dubina korita

Rub

450 mm

780 x 500 mm

760 x 480 mm

160 mm

standard

SPARK - SKX 611-79 - standardna ugradnja

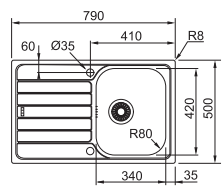

329,00 KM

Završna obrada

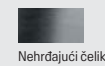

Nehrdajući čelik

FUN broj

101.0554.878



Ormar

Dimenzije Š x D

Ugradni otvor Š x D

Dubina korita

Rub

450 mm

790 x 500 mm

770 x 480 mm

160 mm

slim

SPARK - SKX 620-80 - standardna ugradnja



NOVO

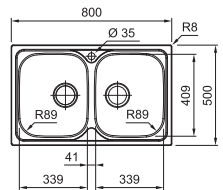

319,00 KM

Završna obrada

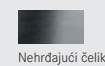

Nehrdajući čelik

FUN broj

101.0712.131

Ormar

Dimenzije Š x D

Ugradni otvor Š x D

Dubina korita

Rub

800 mm (900 završni)

800 x 500 mm

780 x 480 mm

150 mm

standard

SPARK



1  
112.0595.334  
Daska za rezanje



2  
ALL-IN-ONE setovi

# Flash



Fotografija je simbolična.  
Ovaj model sudopera nije u ponudi.

## FLASH - FLN 611-78 - standardna ugradnja



AISI  
304

1

NOVO

159,00 KM

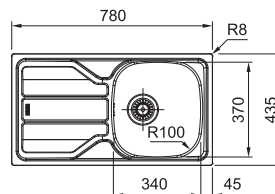

Sudoperi se isporučuju bez kartonske kutije u kompletu s odvodnim elementima i sifonom.

### Završna obrada



Nepolirani  
nehrđajući čelik

### Ormar

Dimenzije Š x D

Ugradni otvor Š x D

Dubina korita

Rub

### FUN broj

101.0708.161



450 mm

780 x 435 mm

760 x 415 mm

150 mm

standard

## FLASH



1

ALL-IN-ONE setovi

# Korita od



# fragranita

# Maris 2.0



MARIS 2.0 - MRG 610-37 TLA - standardna ugradnja

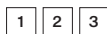

659,00 KM

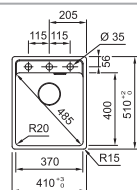

Ormar  
Dimenzije Š x D  
410 x 510 mm  
Ugradni otvor Š x D  
390 x 498 mm (R15)  
Dubina korita  
200 mm  
Rub  
standard



Završna obrada / FUN broj

	114.0658.254 Crna mat		114.0658.256 Glečer bijela
	114.0658.140 Crna		114.0658.257 Kašmir
	114.0658.255 Kameno siva		

MARIS 2.0 - MRG 610-52 TLA - standardna ugradnja

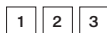

699,00 KM

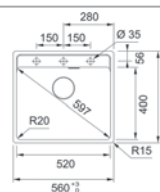

Ormar  
Dimenzije Š x D  
560 x 510 mm  
Ugradni otvor Š x D  
540 x 498 mm (R15)  
Dubina korita  
200 mm  
Rub  
standard



Završna obrada / FUN broj

	114.0658.294 Crna mat		114.0658.296 Glečer bijela
	114.0658.293 Crna		114.0658.297 Kašmir
	114.0658.295 Kameno siva		

MARIS 2.0 - MRG 110-52 A - ugradnja pod radnu ploču

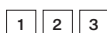

769,00 KM

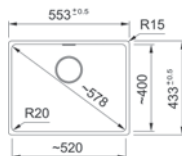

Ormar  
Dimenzije Š x D  
553 x 433 mm  
Ugradni otvor Š x D  
520x400 (R20)  
Dubina korita  
200 mm  
Rub  
slim



Završna obrada / FUN broj

	125.0683.105 Crna mat		125.0683.103 Glečer bijela
	125.0683.101 Crna		125.0683.104 Kašmir
	125.0683.102 Kameno siva		

## MARIS 2.0

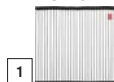

112.0030.882  
Rollmat podložak



112.0188.651  
Mobilni ocjeđivač

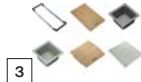

ALL-IN-ONE setovi

MARIS 2.0 - MRG 610-52 - standardna ugradnja

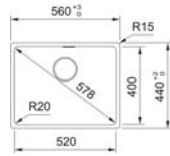
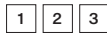

Ormar  
Dimenzije Š x D  
Ugradni otvor Š x D  
Dubina korita  
Rub

600 mm  
560 x 440 mm  
540 x 428 mm (R15)  
200 mm  
standard

589,00 KM

Završna obrada / FUN broj

114.0661.659 Crna  
114.0661.662 Glečer bijela

MARIS 2.0 - MRG 610-52 TL - standardna ugradnja

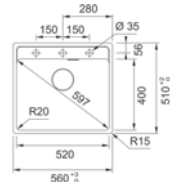
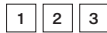

Ormar  
Dimenzije Š x D  
Ugradni otvor Š x D  
Dubina korita  
Rub

600 mm  
560 x 510 mm  
540 x 498 mm (R15)  
200 mm  
standard

629,00 KM

Završna obrada / FUN broj

114.0661.643 Crna  
114.0661.644 Kameno siva  
114.0661.646 Glečer bijela  
114.0661.647 Sahara  
114.0661.648 Kašmir

MARIS 2.0 - MRG 110-52 - ugradnja pod radnu ploču

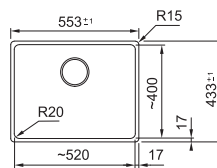
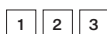

Ormar  
Dimenzije Š x D  
Ugradni otvor Š x D  
Dubina korita  
Rub

600 mm  
553 x 433 mm  
vidi uputu  
200 mm  
slim

659,00 KM

Završna obrada / FUN broj

125.0686.716 Crna  
125.0686.717 Kameno siva  
125.0686.719 Glečer bijela  
125.0686.720 Sahara  
125.0686.721 Kašmir

# Maris



MARIS - MRG 610-54 FTL - standardna ugradnja

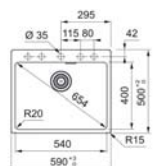

Ormar  
Dimenzije Š x D  
Ugradni otvor Š x D  
Dubina korita  
Rub

600 mm  
590 x 500 mm  
570 x 480 mm  
200 mm  
slim

549,00 KM

Završna obrada / FUN broj

114.0661.699 Crna mat  
114.0661.703 Crna  
114.0661.702 Kameno siva  
114.0661.698 Glečer bijela  
114.0661.705 Sahara  
114.0661.700 Avena  
114.0661.701 Kašmir

MARIS



112.0030.882  
Rollmat podložak

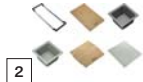

ALL-IN-ONE setovi

# Urban 2.0



URBAN 2.0 - UBG 610-50 A - standardna ugradnja



1 2

599,00 KM

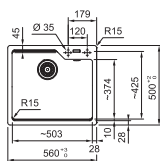

Ormar 600 mm  
 Dimenzije Š x D 560 x 500 mm  
 Ugradni otvor Š x D 540 x 480 mm (R15)  
 Dubina korita 220 mm  
 Rub slim top



Završna obrada	FUN broj
Crna mat	114.0682.641
Crna	114.0682.644
Glečer bijela	114.0682.600

URBAN 2.0 - UBG 610-50 - standardna ugradnja



1 2

529,00 KM

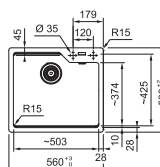

Ormar 600 mm  
 Dimenzije Š x D 560 x 500 mm  
 Ugradni otvor Š x D 540 x 480 mm (R15)  
 Dubina korita 230 mm  
 Rub slim top



Završna obrada / FUN broj	
114.0686.798 Crna mat	114.0686.796 Glečer bijela
114.0686.793 Crna	114.0686.791 Sahara
114.0686.797 Kameno siva	114.0686.794 Kašmir

URBAN 2.0



1 112.0595.334 Daska za rezanje

2 ALL-IN-ONE setovi



PAMIRA - ROG 610-41 - standardna ugradnja

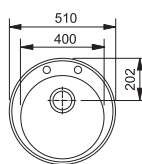





Ormar 450 mm  
 Dimenzije Š x D Ø 510 mm  
 Ugradni otvor Š x D Ø 493 mm  
 Dubina korita 195 mm  
 Rub standard

439,00 KM



Završna obrada / FUN broj

 114.0199.717 Crna	 114.0009.509 Glečer bijela
 114.0009.505 Kameno siva	 114.0009.506 Avena

# Sudoperi od



# fragranita



MARIS - MRG 611-62 - standardna ugradnja



1 2 4

559,00 KM

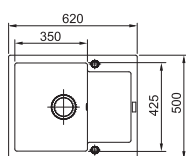

Ormar 450 mm  
Dimenzije Š x D 620 x 500 mm  
Ugradni otvor Š x D 600 x 480 mm  
Dubina korita 200 mm  
Rub standard



Završna obrada / FUN broj

114.0627.370 Crna mat	114.0253.323 Glečer bijela
114.0253.322 Crna	114.0302.708 Kašmir
114.0253.324 Kameno siva	



MARIS - MRG 611-A - standardna ugradnja



1 2 4

599,00 KM

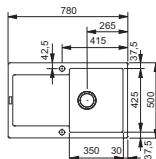

Ormar 450 mm  
Dimenzije Š x D 780 x 500 mm  
Ugradni otvor Š x D 760 x 480 mm  
Dubina korita 200 mm  
Rub standard



Završna obrada / FUN broj

114.0627.367 Crna mat	114.0055.697 Glečer bijela
114.0176.603 Crna	114.0302.705 Kašmir
114.0055.695 Kameno siva	



MARIS - MRG 611-78 XL - standardna ugradnja



2 3 5

659,00 KM

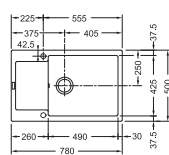

Ormar 600 mm  
Dimenzije Š x D 780 x 500 mm  
Ugradni otvor Š x D 760 x 480 mm  
Dubina korita 200 mm  
Rub standard



Završna obrada / FUN broj

114.0627.365 Crna mat	114.0479.022 Glečer bijela
114.0479.032 Crna	114.0479.027 Kašmir
114.0479.030 Kameno siva	



MARIS - MRG 611-100 XL - standardna ugradnja



2 3 4 5

679,00 KM

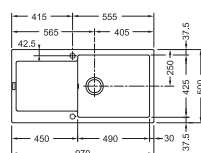

Ormar 600 mm  
Dimenzije Š x D 970 x 500 mm  
Ugradni otvor Š x D 950 x 480 mm  
Dubina korita 200 mm  
Rub standard



Završna obrada / FUN broj

114.0627.363 Crna mat	114.0378.095 Glečer bijela
114.0378.126 Crna	114.0378.121 Kašmir
114.0378.124 Kameno siva	



## MARIS



1  
112.0066.060  
Kadica/cjedilo inox

2  
112.0595.334  
Daska za rezanje

3  
112.0080.355  
Rollmat podloška

4  
ALL-IN-ONE setovi

MARIS - MRG 611 - standardna ugradnja



2 3 4 5

549,00 KM

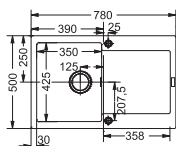

Ormar  
Dimenzije Š x D  
Ugradni otvor Š x D  
Dubina korita  
Rub

450 mm (600 završni)  
780 x 500 mm  
760 x 480 mm  
200 mm  
standard



Završna obrada / FUN broj

114.0630.781 Crna mat	114.0153.909 Glečer bijela
114.0157.493 Crna	114.0066.567 Sahara
114.0066.566 Kameno siva	114.0490.279 Kašmir



# Urban 2.0



URBAN 2.0 - UBG 611-78 XL - standardna ugradnja



1 2 3 4 5

599,00 KM

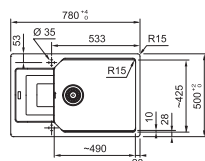

Ormar  
Dimenzije Š x D  
Ugradni otvor Š x D  
Dubina korita  
Rub

600 mm  
780 x 500 mm  
760 x 480 mm (R15)  
220 mm  
slim top



Završna obrada	FUN broj
Crna mat	114.0682.566
Crna	114.0682.570
Kameno siva	114.0682.569
Glečer bijela	114.0682.565
Kašmir	114.0682.567



URBAN 2.0 - UBG 611-86 A - standardna ugradnja



1 2 3 4 5

619,00 KM

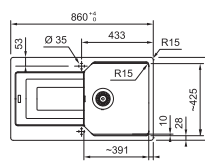

Ormar  
Dimenzije Š x D  
Ugradni otvor Š x D  
Dubina korita  
Rub

500 mm  
860 x 500 mm  
840 x 480 mm (R15)  
220 mm  
slim top



Završna obrada	FUN broj
Crna mat	114.0682.521
Crna	114.0682.524
Kameno siva	114.0682.523
Glečer bijela	114.0682.510
Kašmir	114.0682.522



URBAN 2.0 - UBG 611-100 A - standardna ugradnja



1 2 3  
4 5

679,00 KM

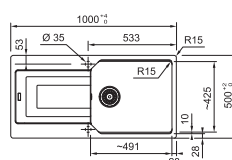

Ormar  
Dimenzije Š x D  
Ugradni otvor Š x D  
Dubina korita  
Rub

600 mm  
1000 x 500 mm  
980 x 480 mm (R15)  
220 mm  
slim top



Završna obrada	FUN broj
Crna mat	114.0682.527
Crna	114.0682.530
Kameno siva	114.0682.529
Glečer bijela	114.0682.525
Kašmir	114.0682.528



MARIS



A 1  
112.0057.214  
Kadica/cjedilo inox

2  
112.0066.060  
Kadica/cjedilo inox

3  
112.0595.334  
Daska za rezanje

4  
112.0080.355  
Rollmat podloška

5  
ALL-IN-ONE setovi

URBAN 2.0



1  
112.0566.182  
Kadica/cjedilo plastika

2  
112.0066.060  
Kadica/cjedilo inox

3  
112.0595.334  
Daska za rezanje

4  
112.0256.867  
Rollmat podloška

5  
ALL-IN-ONE setovi

URBAN 2.0 - UBG 611-62 - standardna ugradnja



1 2 3 4 5

529,00 KM

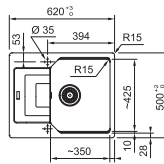

Ormar 450 mm  
Dimenzije Š x D 620 x 500 mm  
Ugradni otvor Š x D 600 x 480 mm (R15)  
Dubina korita 220 mm  
Rub slim top



Završna obrada / FUN broj

	114.0686.739 Crna mat		114.0686.740 Sahara
	114.0686.742 Crna		114.0686.741 Avena
	114.0686.745 Kameno siva		114.0686.743 Kašmir
	114.0686.744 Glečer bijela		



URBAN 2.0 - UBG 611-78 - standardna ugradnja



1 2 3 4 5

559,00 KM

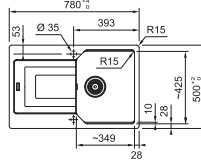

Ormar 450 mm  
Dimenzije Š x D 780 x 500 mm  
Ugradni otvor Š x D 760 x 480 mm (R15)  
Dubina korita 220 mm  
Rub slim top



Završna obrada / FUN broj

	114.0686.746 Crna mat		114.0686.747 Sahara
	114.0686.749 Crna		114.0686.748 Avena
	114.0686.752 Kameno siva		114.0686.750 Kašmir
	114.0686.751 Glečer bijela		



# Basis



BASIS - BFG 611-62 - standardna ugradnja



2 3

499,00 KM

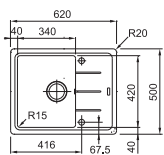

Ormar 450 mm  
Dimenzije Š x D 620 x 500 mm  
Ugradni otvor Š x D 600 x 480 mm (R20)  
Dubina korita 200 mm  
Rub standard



Završna obrada / FUN broj

	114.0301.331 Crna		114.0301.342 Avena
	114.0301.333 Kameno siva		114.0301.903 Kašmir
	114.0301.335 Glečer bijela		



BASIS - BFG 611-78 - standardna ugradnja



2 3

569,00 KM

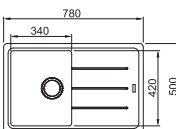

Ormar 450 mm  
Dimenzije Š x D 780 x 500 mm  
Ugradni otvor Š x D 760 x 480 mm (R20)  
Dubina korita 200 mm  
Rub standard



Završna obrada / FUN broj

	114.0256.610 Crna		114.0256.609 Avena
	114.0256.612 Kameno siva		114.0301.907 Kašmir
	114.0256.611 Glečer bijela		



BASIS



A 112.0250.014  
Kadica/cjedilo inox

B 112.0595.334  
Daska za rezanje

C ALL-IN-ONE setovi

# Boston



**BOSTON - BFG 611-78** - standardna ugradnja



2 3

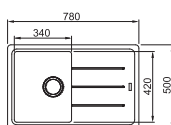

Ormar 450 mm  
Dimenzije Š x D 780 x 500 mm  
Ugradni otvor Š x D 760 x 480 mm  
Dubina korita 200 mm  
Rub standard

529,00 KM



Završna obrada / FUN broj

114.0275.938 Crna  
114.0275.955 Glečer bijela  
114.0275.956 Avena



**BOSTON - BFG 611-86** - standardna ugradnja



2 3

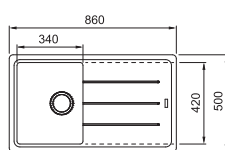

Ormar 450 mm  
Dimenzije Š x D 860 x 500 mm  
Ugradni otvor Š x D 840 x 480 mm  
Dubina korita 200 mm  
Rub standard

549,00 KM



Završna obrada / FUN broj

114.0370.202 Crna  
114.0370.205 Glečer bijela  
114.0370.150 Sahara  
114.0370.206 Avena



**BOSTON - BFG 611-97** - standardna ugradnja



2 3

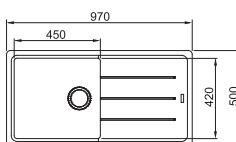

Ormar 600 mm  
Dimenzije Š x D 970 x 500 mm  
Ugradni otvor Š x D 950 x 480 mm  
Dubina korita 200 mm  
Rub standard

559,00 KM



Završna obrada / FUN broj

114.0276.112 Crna  
114.0276.119 Glečer bijela  
114.0276.080 Sahara  
114.0276.120 Avena



## BOSTON



1  
112.0250.014  
Kadica/cjedilo inox



2  
112.0595.334  
Daska za rezanje

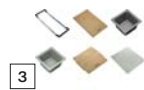

3  
ALL-IN-ONE setovi

# Strata



STRATA - STG 614-78 - standardna ugradnja



469,00 KM

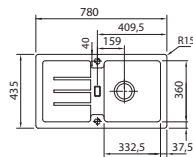

Ormar 450 mm  
 Dimenzije Š x D 780 x 435 mm  
 Ugradni otvor Š x D 760 x 415 mm (R20)  
 Dubina korita 165 mm  
 Rub standard



#### Završna obrada / FUN broj

 114.0657.828 Crna mat	 114.0303.670 Glečer bijela
 114.0303.666 Crna	 114.0303.672 Avena
 114.0303.671 Kameno siva	 114.0303.684 Kašmir



#### STRATA



1

ALL-IN-ONE setovi

# Dodatni pribor

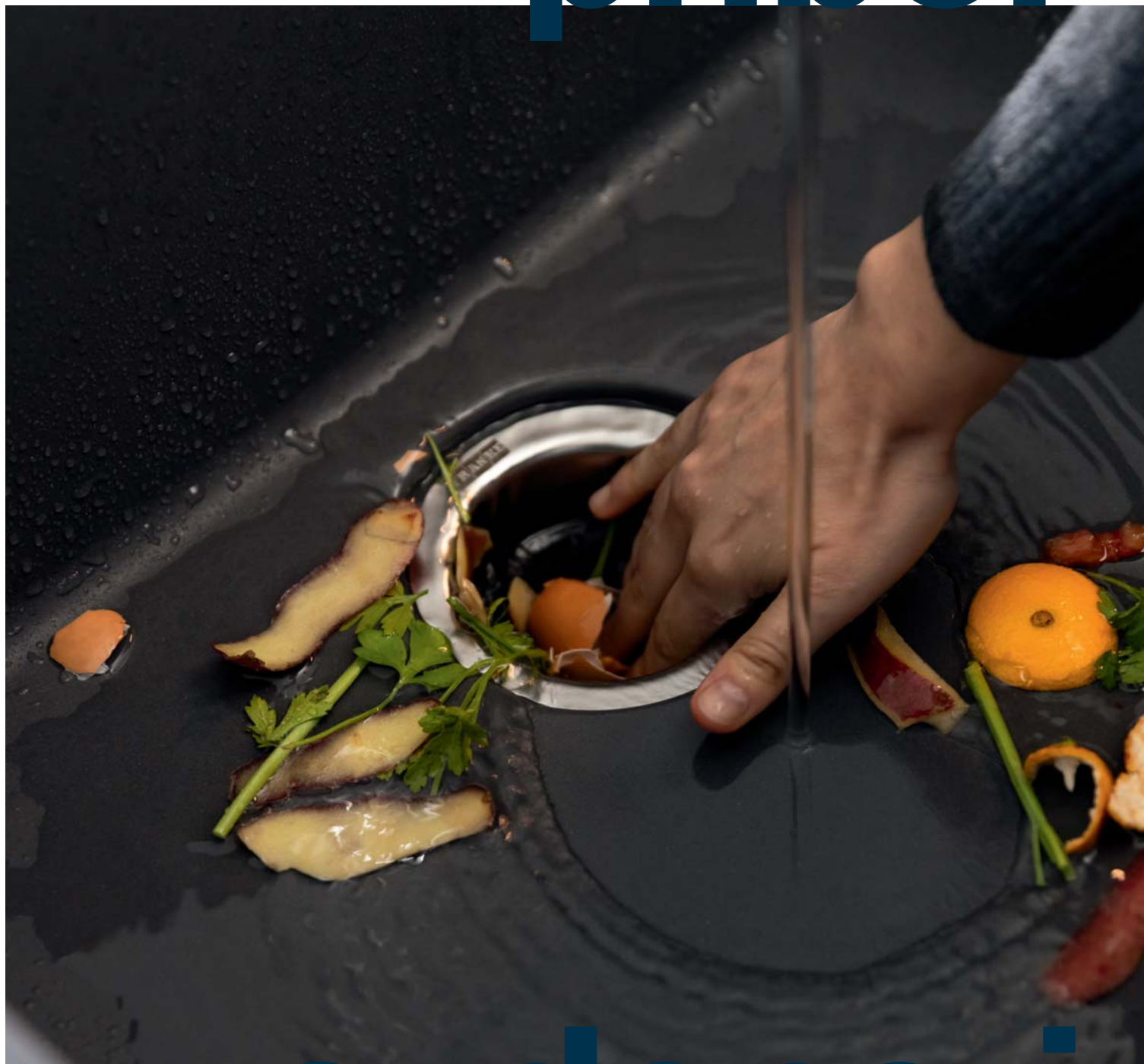

# sudoperi

# Drobnice otpada



SLIM 125



799,00 KM

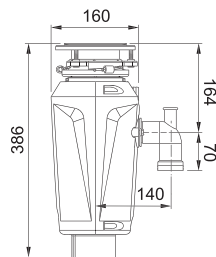

Završna obrada	FUN broj
Nehrđajući čelik	134.0715.094
Komponente za drobljenje	Nehrđajući čelik
Snaga (KS)	1,25
Kapacitet komore	0,86 l
Težina	5,93 kg
Napomena	Pneumatski gumb uključen, antibakterijski tretman

SLIM 75



669,00 KM

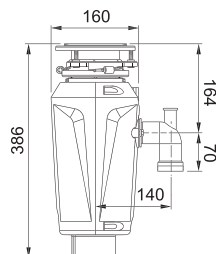

Završna obrada	FUN broj
Nehrđajući čelik	134.0715.096
Komponente za drobljenje	Nehrđajući čelik
Snaga (KS)	0,75
Kapacitet komore	0,86 l
Težina	6,8 kg
Napomena	Pneumatski gumb uključen, antibakterijski tretman

SLIM 50



569,00 KM

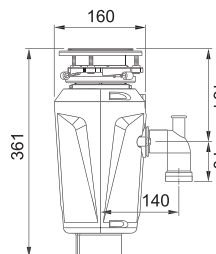

Završna obrada	FUN broj
Nehrđajući čelik	134.0715.098
Komponente za drobljenje	Nehrđajući čelik
Snaga (KS)	0,50
Kapacitet komore	0,86 l
Težina	6,8 kg
Napomena	Pneumatski gumb uključen, antibakterijski tretman

# Slavine





FOX PRO DOCCIA

569,00 KM

LINA SEMI-PRO

479,00 KM

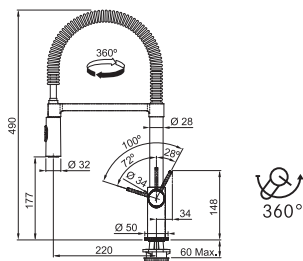

Završna obrada Krom  
FUN broj 115.0486.993

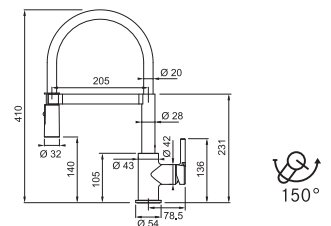

Završna obrada  
Krom/crna 115.0626.085  
Krom/siva 115.0626.087  
Krom/bijela 115.0626.088

ACTIVE J DOCCIA

582,00 KM

ACTIVE J

439,00 KM

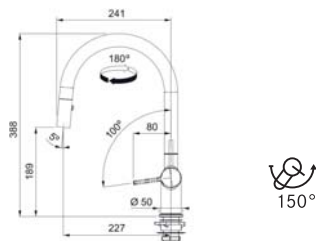

Završna obrada Krom  
FUN broj 115.0653.401

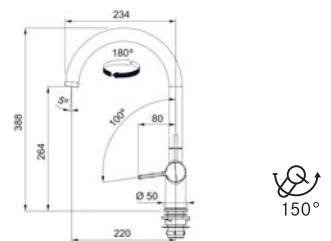

Završna obrada Krom  
FUN broj 115.0653.395

ACTIVE L DOCCIA

549,00 KM

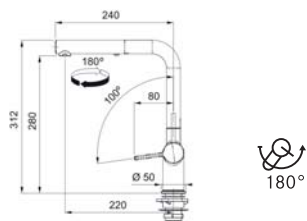

Završna obrada: Krom  
FUN broj: 115.0653.379

ACTIVE L

428,00 KM

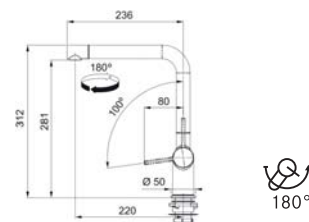

Završna obrada: Krom  
FUN broj: 115.0653.298

SIRIUS L DOCCIA

369,00 KM

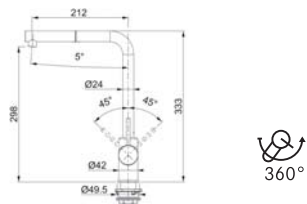

Završna obrada: Krom  
FUN broj: 115.0668.280

LINA L

319,00 KM

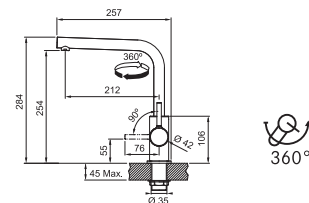

Završna obrada: Krom  
FUN broj: 115.0693.230

LINA J DOCCIA

340,00 KM

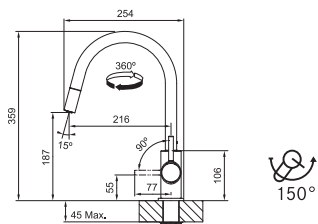

Završna obrada: Krom  
FUN broj: 115.0693.229

LINA XL J

285,00 KM

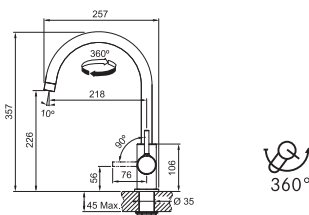

Završna obrada: Krom  
FUN broj: 115.0693.228

FOX

252,00 KM

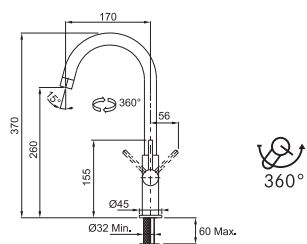

Završna obrada: Krom  
FUN broj: 115.0250.143

NOVARA PLUS DOCCIA

307,00 KM

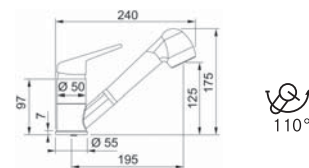

Završna obrada: Krom  
FUN broj: 115.0347.111

NOVARA PLUS

159,12 KM

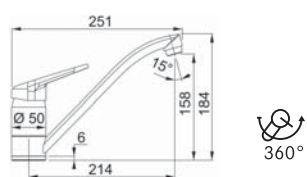

Završna obrada: Krom  
FUN broj: 115.0347.142

BASIC

109,00 KM

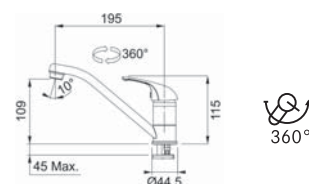

Završna obrada: Krom  
FUN broj: 115.0707.619

# Crna mat



ACTIVE L DOCCIA

799,00 KM

ACTIVE L

549,00 KM

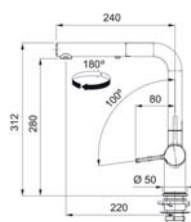

Završna obrada  
Crna mat

FUN broj  
115.0653.382

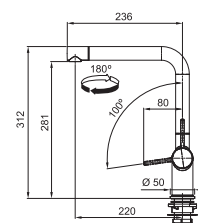

Završna obrada  
Crna mat

FUN broj  
115.0653.371



LINA DOCCIA

399,00 KM

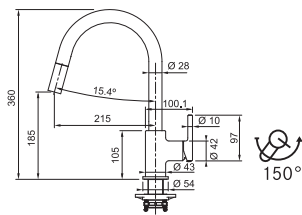

Završna obrada: Crna mat  
FUN broj: 115.0626.053

LINA XL

274,00 KM

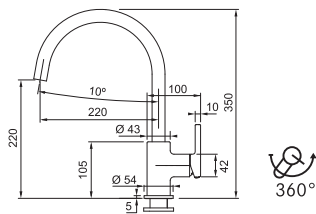

Završna obrada: Crna mat  
FUN broj: 115.0626.019

NOVARA PLUS DOCCIA

285,00 KM

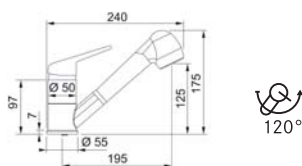

Završna obrada: Crna mat  
FUN broj: 115.0659.840

URBAN DOCCIA

582,00 KM

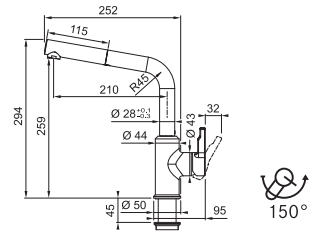

Završna obrada: Crna mat  
FUN broj: 115.0627.523

URBAN

461,00 KM

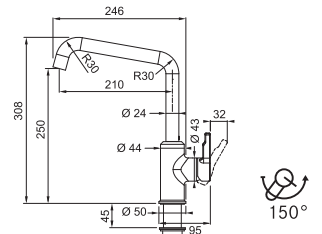

Završna obrada: Crna mat  
FUN broj: 115.0627.524



NOVARA PLUS

186,00 KM

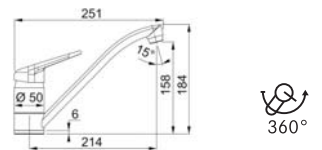

Završna obrada: Crna mat  
FUN broj: 115.0659.961

# Krom-fragranit

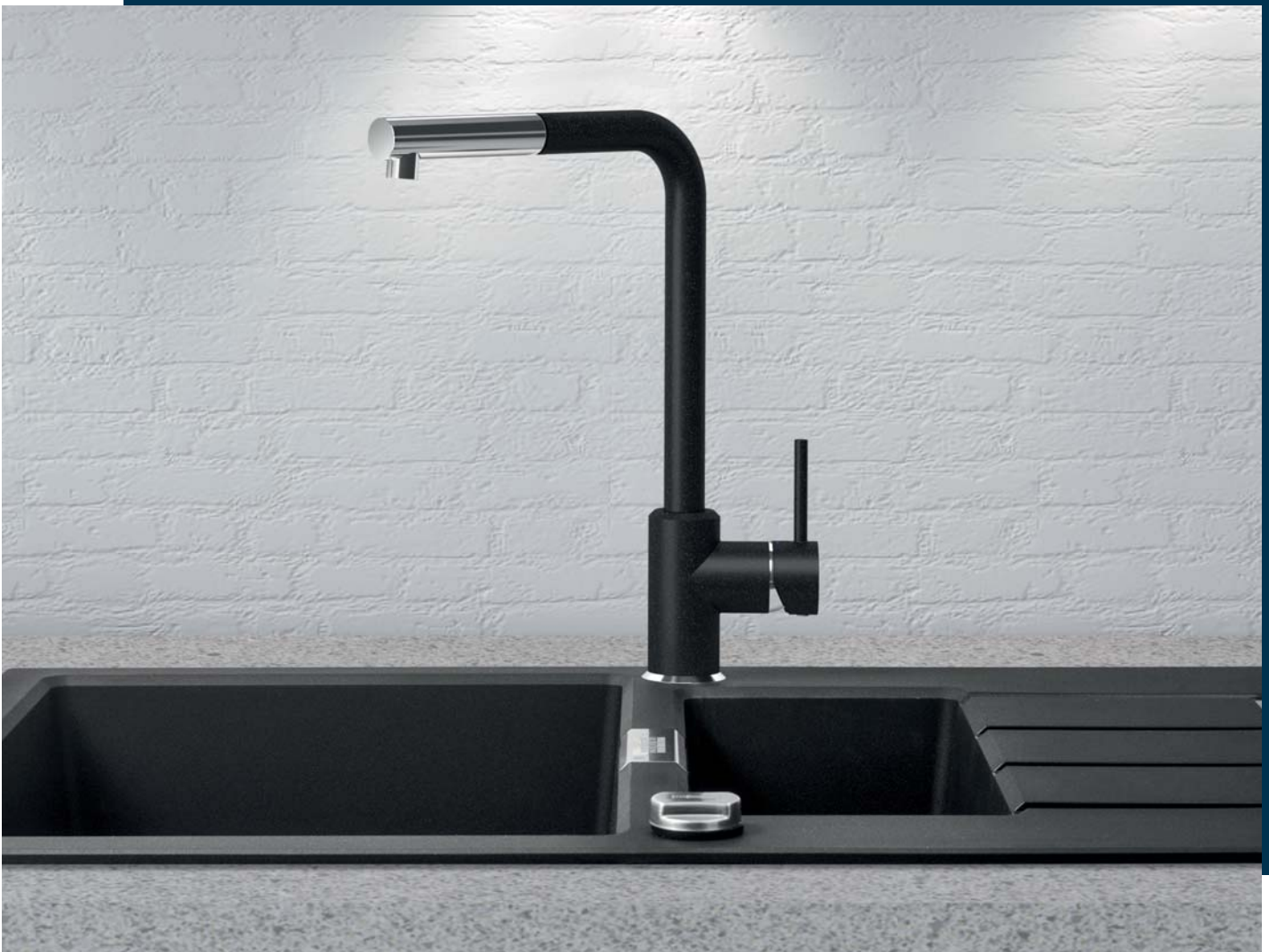

SIRIUS L DOCCIA

439,00 KM

ORBIT DOCCIA

369,00 KM

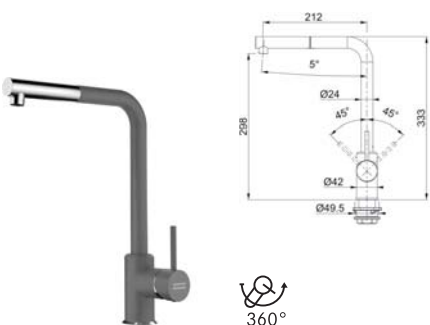

Završna obrada / FUN broj

- 115.0668.279 Krom/Crna
- 115.0668.381 Krom/Kameno siva
- 115.0668.382 Krom/Glečer bijela
- 115.0668.383 Krom/Avena



Završna obrada / FUN broj

- 115.0623.057 Krom/Crna
- 115.0623.141 Krom/Kameno siva
- 115.0623.139 Krom/Glečer bijela
- 115.0623.059 Krom/Sahara
- 115.0623.136 Krom/Avena
- 115.0623.147 Krom/Kašmir

ORBIT

329,00 KM

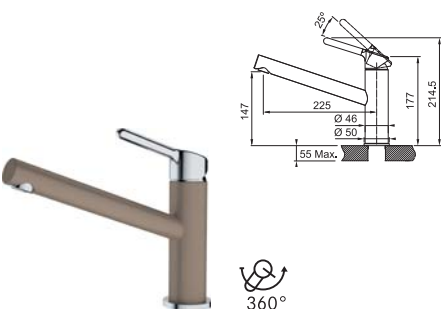

Završna obrada / FUN broj

- 115.0623.056 Krom/Crna
- 115.0623.140 Krom/Kameno siva
- 115.0623.137 Krom/Glečer bijela
- 115.0623.135 Krom/Avena
- 115.0623.146 Krom/Kašmir



# Fragranit



ACTIVE PLUS L DOCCIA

736,00 KM

ACTIVE PLUS L

599,00 KM

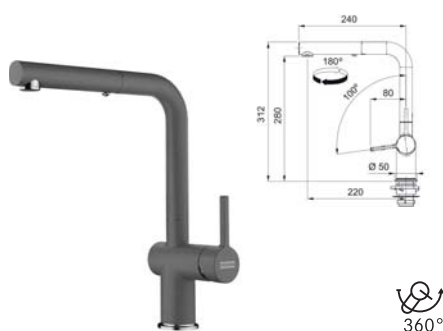

Završna obrada / FUN broj

- 115.0653.384 Krom/Crna
- 115.0653.385 Krom/Kameno siva
- 115.0653.387 Krom/Glečer bijela
- 115.0653.388 Krom/Sahara
- 115.0653.389 Krom/Kašmir



Završna obrada / FUN broj

- 115.0653.373 Krom/Crna
- 115.0653.374 Krom/Kameno siva
- 115.0653.376 Krom/Glečer bijela
- 115.0653.377 Krom/Sahara
- 115.0653.378 Krom/Kašmir

URBAN DOCCIA

549,00 KM

URBAN

428,00 KM

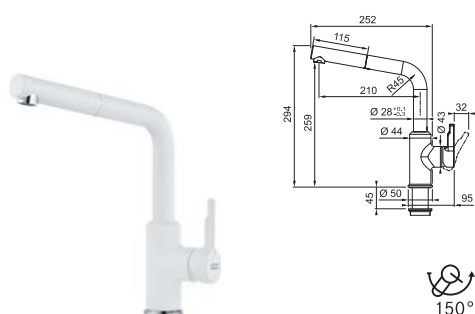

Završna obrada / FUN broj

- 115.0595.091 Crna
- 115.0595.089 Kameno siva
- 115.0595.088 Glečer bijela
- 115.0595.085 Avena
- 115.0595.093 Kašmir

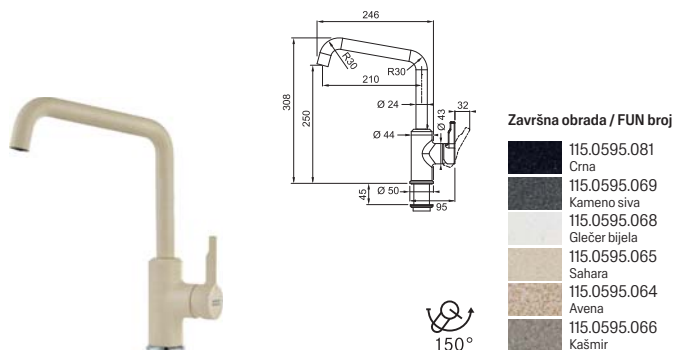

Završna obrada / FUN broj

- 115.0595.081 Crna
- 115.0595.069 Kameno siva
- 115.0595.068 Glečer bijela
- 115.0595.065 Sahara
- 115.0595.064 Avena
- 115.0595.066 Kašmir

LINA DOCCIA

395,00 KM

LINA XL

351,00 KM

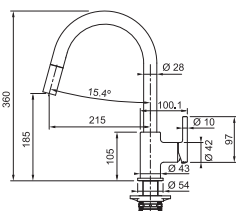

Završna obrada / FUN broj

- 115.0626.055 Crna
- 115.0626.057 Kameno siva
- 115.0626.081 Glečer bijela
- 115.0626.082 Sahara
- 115.0626.083 Avena
- 115.0626.084 Kašmir

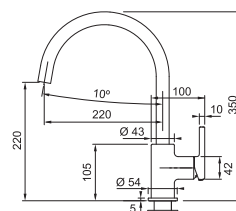

Završna obrada / FUN broj

- 115.0626.020 Crna
- 115.0626.022 Kameno siva
- 115.0626.024 Glečer bijela
- 115.0626.025 Sahara
- 115.0626.026 Avena
- 115.0626.028 Kašmir



NOVARA PLUS DOCCIA

373,00 KM

NOVARA PLUS

252,00 KM

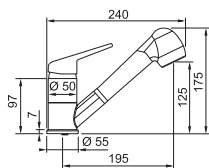

Završna obrada / FUN broj

- 115.0470.675 Crna
- 115.0470.670 Kameno siva
- 115.0470.669 Glečer bijela
- 115.0470.663 Sahara
- 115.0470.665 Avena
- 115.0470.666 Kašmir

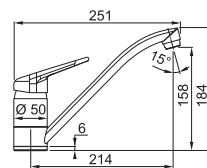

Završna obrada / FUN broj

- 115.0470.661 Crna
- 115.0470.659 Kameno siva
- 115.0470.658 Glečer bijela
- 115.0470.653 Sahara
- 115.0470.654 Avena
- 115.0470.655 Kašmir



# Rustikalne



OLD ENGLAND

539,00 KM

549,00 KM

Krom

Boja bronce  
Bakar

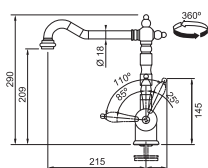

Završna obrada / FUN broj

- 115.0060.360 Krom
- 115.0028.205 Boja bronce
- 115.0028.208 Bakar



# Simboli

## Simboli vam omogućuju brz pregled tehničkih karakteristika sudopera:



### TVORNIČKI UGRAĐENA BRTVA

Optimalan estetski učinak i maksimalna jednostavnost ugradnje.



### MEHANIČKI POVLAČNI DALJINSKI OTVARAČ PILETE

Omogućuje pražnjenje vode iz sudopera bez močenja ruku. Upravljačka ručica nalazi se pored slavine.



### MEHANIČKI ZAKRETNI DALJINSKI OTVARAČ PILETE

Omogućuje pražnjenje vode iz sudopera bez močenja ruku. Upravljačka ručica nalazi se pored slavine.



### "PUSH-PULL" DALJINSKI OTVARAČ PILETE

Omogućuje pražnjenje vode iz sudopera bez močenja ruku. Upravljačka ručica nalazi se pored slavine.



### DODATNI PRIBOR KOJI JE UKLJUČEN UZ SUDOPER

Velika ponuda raznih dodataka na nekim modelima omogućava da se korito sudopera maksimalno iskoristi (kao cjedilo, prostor za rezanje i pripremanje namirnica itd.).



### TIS

Podupirač slavine



### MEHANIČKI POVLAČNI DALJINSKI OTVARAČ PILETE

Omogućuje pražnjenje vode iz sudopera bez močenja ruku. Upravljačka ručica nalazi se pored slavine.



### MEHANIČKI ZAKRETNI DALJINSKI OTVARAČ PILETE

Omogućuje pražnjenje vode iz sudopera bez močenja ruku. Upravljačka ručica nalazi se pored slavine.



### DOZATOR TEKUĆEG DETERDŽENTA

Vrlo koristan dodatak koji omogućuje da je deterdžent uvijek nadohvat ruke te optimizira pranje. Prije kupnje provjeriti mogućnost ugradnje na sudoper.



### DROBILICA ZA OTPAD

Zahvaljujući ovom korisnom uređaju, gospodarenje organskim otpadom postaje vrlo jednostavno.



### INTEGRIRANI ODVOD

Odvod sudopera ne montira se naknadno, nego je utisnut na samom sudoperu. Tako su izbjegnuti spojevi i procjepi u kojima se nakupljaju nečistoće.



### RUB STANDARD



### RUB SLIM



### RUB SLIM TOP (SEMIFILO)



### RUB SLIM TOP



### UGRADNJA POD RADNU PLOČU



### SUDOPER S OCJEĐIVAČEM DESNO



### SUDOPER S OCJEĐIVAČEM LIJEVO



### REVERZIBILNI SUDOPER

# Načini ugradnje sudopera

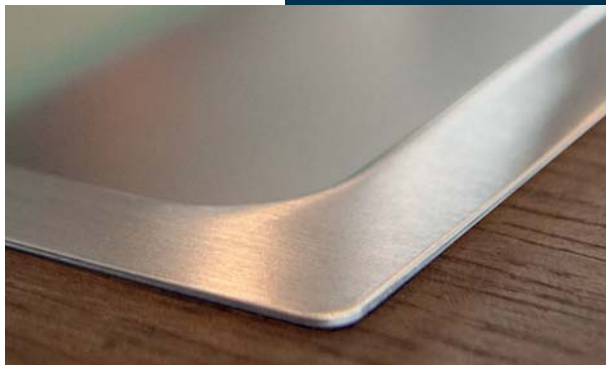

## Načini ugradnje sudopera: razlike u rubu sudopera



RUB  
SLIM TOP

### Poluporavnana standardna ugradnja - moderno rješenje

Novi način ugradnje na čvrste ili laminirane radne ploče. Izuzetno laka ugradnja i iznimna elegancija.

Rub slim top je debljine 1 mm.

Prikladan materijal: nehrđajući čelik

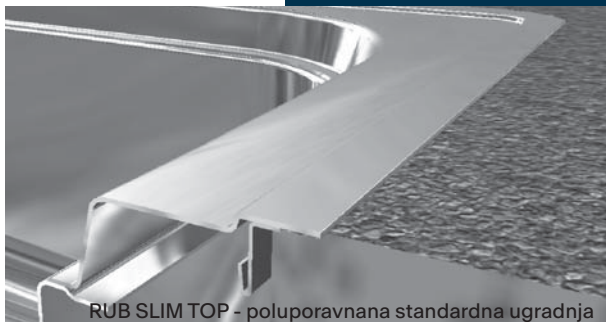

RUB SLIM TOP - poluporavnana standardna ugradnja



RUB  
SLIM TOP

### Poravnana ugradnja - purističko rješenje

Način ugradnje urezivanjem radne ploče za debljinu ruba sudopera, tako da su sudoper i radna ploča, u konačnici, potpuno u ravnini.

Rub slim top je debljine 1 mm.

Prikladni materijali: nehrđajući čelik, Fragranit+ i Fraceram keramika

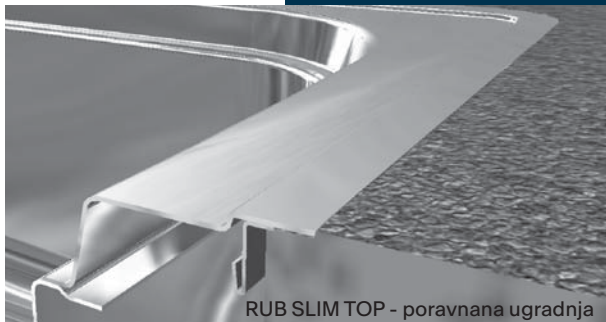

RUB SLIM TOP - poravnana ugradnja



### Ugradnja pod radnu ploču - elegantno rješenje

Ugradnja sudopera pod radnu ploču povećava iskoristivu radnu površinu i bitno olakšava rad u kuhinji, kao i njeno čišćenje.

Prikladni materijali: nehrđajući čelik, Fragranit+ i Fraceram keramika



RUB  
STANDARD



RUB  
SLIM

### Standardna ugradnja - klasično rješenje

Kod standardne ugradnje, rub je izbočen. Izbočeni rub daje sudoperu dodatnu stabilnost.

Sudoper je fiksiran u otvoru radne ploče, koja može biti izrađena od bilo kojeg materijala. Ovakav izgled sudopera izuzetno odgovara dizajnu kuhinja u klasičnom stilu.

Rub standard je debljine 6 mm, a rub slim je debljine 4 mm što mu daje veću eleganciju.

Prikladni materijali: nehrđajući čelik, Fragranit+ i Fraceram keramika







Vrijedi za sudopere.



Vrijedi za električne uređaje osim za drobilice otpada.



Vrijedi za drobilice otpada i slavine.

Izražene cijene su preporučene maloprodajne cijene.  
Pridržano pravo na izmjene. Proizvođač i firma Gemma B&D kao ekskluzivni uvoznik i distributer zadržavaju pravo promjene podataka u svakom trenutku i bez prethodne najave i nisu odgovorni za eventualne štamparske greške.  
Fotografije uređaja u katalogu ilustrativnog su karaktera i moguća su odstupanja od stvarnog izgleda.

## Prodajni centri Bosna i Hercegovina

	Radno vrijeme	Kontakt podaci
<b>Centar Mostar</b> Gnojnice bb	<b>pon-pet:</b> 08:00 - 16:30 <b>sub:</b> 08:00 - 14:00	<b>Tel:</b> +387 36 871 931 <b>E-mail:</b> mostar@elgrad.ba
<b>Centar Sarajevo</b> Halilovići 6	<b>pon-pet:</b> 07:00 - 20:30 <b>sub:</b> 08:00 - 14:00	<b>Tel:</b> +387 33 789 285 <b>E-mail:</b> sarajevo@elgrad.ba
<b>Centar Banja Luka</b> Veljka Mlađenovića bb, Poslovna zona AD	<b>pon-pet:</b> 07:00 - 19:00 <b>sub:</b> 08:00 - 14:00	<b>Tel:</b> +387 51 490 680 <b>E-mail:</b> banjaluka@elgrad.ba
<b>Centar Tuzla</b> Magistralni put 51b i 51c, Industrijska zona Maline, Živinice	<b>pon-pet:</b> 08:00 - 18:00 <b>sub:</b> 08:00 - 14:00	<b>Tel:</b> +387 35 831 931 <b>E-mail:</b> tuzla@elgrad.ba